

User Manual



HDVG1
HDTV Digital Video Generator
071-0593-50

Copyright © Tektronix, Inc. All rights reserved.

Tektronix products are covered by U.S. and foreign patents, issued and pending. Information in this publication supercedes that in all previously published material. Specifications and price change privileges reserved.

Tektronix, Inc., P.O. Box 500, Beaverton, OR 97077

TEKTRONIX and TEK are registered trademarks of Tektronix, Inc.

WARRANTY

Tektronix warrants that this product will be free from defects in materials and workmanship for a period of one (1) year from the date of shipment. If any such product proves defective during this warranty period, Tektronix, at its option, either will repair the defective product without charge for parts and labor, or will provide a replacement in exchange for the defective product.

In order to obtain service under this warranty, Customer must notify Tektronix of the defect before the expiration of the warranty period and make suitable arrangements for the performance of service. Customer shall be responsible for packaging and shipping the defective product to the service center designated by Tektronix, with shipping charges prepaid. Tektronix shall pay for the return of the product to Customer if the shipment is to a location within the country in which the Tektronix service center is located. Customer shall be responsible for paying all shipping charges, duties, taxes, and any other charges for products returned to any other locations.

This warranty shall not apply to any defect, failure or damage caused by improper use or improper or inadequate maintenance and care. Tektronix shall not be obligated to furnish service under this warranty a) to repair damage resulting from attempts by personnel other than Tektronix representatives to install, repair or service the product; b) to repair damage resulting from improper use or connection to incompatible equipment; or c) to service a product that has been modified or integrated with other products when the effect of such modification or integration increases the time or difficulty of servicing the product.

THIS WARRANTY IS GIVEN BY TEKTRONIX WITH RESPECT TO THIS PRODUCT IN LIEU OF ANY OTHER WARRANTIES, EXPRESSED OR IMPLIED. TEKTRONIX AND ITS VENDORS DISCLAIM ANY IMPLIED WARRANTIES OF MERCHANTABILITY OR FITNESS FOR A PARTICULAR PURPOSE. TEKTRONIX' RESPONSIBILITY TO REPAIR OR REPLACE DEFECTIVE PRODUCTS IS THE SOLE AND EXCLUSIVE REMEDY PROVIDED TO THE CUSTOMER FOR BREACH OF THIS WARRANTY. TEKTRONIX AND ITS VENDORS WILL NOT BE LIABLE FOR ANY INDIRECT, SPECIAL, INCIDENTAL, OR CONSEQUENTIAL DAMAGES IRRESPECTIVE OF WHETHER TEKTRONIX OR THE VENDOR HAS ADVANCE NOTICE OF THE POSSIBILITY OF SUCH DAMAGES.

Table of Contents

General Safety Summary	v
About This Manual	vii
Related Manuals	vii
Contacting Tektronix	viii

Getting Started

Getting Started	1-1
Product Description	1-1
Accessories	1-2
Option	1-3
Functional Check	1-3
Procedure	1-3

Operating Basics

Functional Overview	2-1
Outputs	2-2
Online Help	2-2
Operating Procedures	2-3
Power On and Select the Module	2-4
Select the Output Signal	2-5
Active Signal Parameters	2-7
Video Parameters	2-8
Text Overlay	2-10
Signal Information	2-12
Module Parameters	2-13
Circle Overlay	2-14
Enable/Disable the Output Signal	2-15
Embedded Audio	2-15
Logo Overlay	2-17
Logo File Utilities	2-18
Timing	2-21
Trigger Output	2-22

Syntax and Commands

Syntax	3-1
Programming Model	3-1
SCPI Commands and Queries	3-4
Functional Command Groups	3-5
MMemory	3-5
Output	3-6
Sense	3-7
Source	3-7
:OUTPut Commands	3-9
Command Tree	3-10
:OUTPut:STATe(?)	3-11

:OUTPut:CIRClE:STATe(?)	3-12
:OUTPut:CIRClE:DIAMeter(?)	3-13
:OUTPut:CIRClE:POSition:HORizontal(?)	3-14
:OUTPut:CIRClE:POSition:VERTical(?)	3-15
:OUTPut:CIRClE:RESet	3-16
:OUTPut:EAUDio:STATe(?)	3-17
:OUTPut:EAUDio:CHANnel<n>:STATe(?)	3-18
:OUTPut:EAUDio:CHANnel<n>:AMPLitude(?)	3-19
:OUTPut:EAUDio:CHANnel<n>:FREQuency(?)	3-20
:OUTPut:EAUDio:GRoup<n>:PREEmphasis(?)	3-21
:OUTPut:EAUDio:GRoup<n>:NBITs(?)	3-22
:OUTPut:EAUDio:GRoup<n>:SAMPling(?)	3-23
:OUTPut:EAUDio:NGRoups(?)	3-24
:OUTPut:EAUDio:SGRoups(?)	3-25
:OUTPut:LOGO:STATe(?)	3-26
:OUTPut:LOGO:POSition:HORizontal(?)	3-27
:OUTPut:LOGO:POSition:VERTical(?)	3-28
:OUTPut:LOGO:RESet	3-29
:OUTPut:LOGO:SElect(?)	3-30
:OUTPut:TEXT:STATe(?)	3-31
:OUTPut:TEXT:DATA(?)	3-32
:OUTPut:TEXT:POSition:HORizontal(?)	3-33
:OUTPut:TEXT:POSition:VERTical(?)	3-34
:OUTPut:TEXT:RESet	3-35
:OUTPut:TRIGger:CURSor:STATe(?)	3-36
:OUTPut:TRIGger:POSition:HORizontal(?)	3-37
:OUTPut:TRIGger:POSition:HORizontal:STEP(?)	3-38
:OUTPut:TRIGger:POSition:HORizontal:SAMPle(?)	3-39
:OUTPut:TRIGger:POSition:HORizontal:SAMPle:STEP(?)	3-40
:OUTPut:TRIGger:POSition:VERTical(?)	3-41
:OUTPut:TRIGger:POSition:VERTical:STEP(?)	3-42
:OUTPut:TRIGger:TYPE(?)	3-43
:OUTPut:TRIGger:RESet	3-44
:SENSe Subsystem	3-45
Command Tree	3-45
:SENSe:CORRection:MDELay:HORizontal(?)	3-46
:SENSe:CORRection:MDELay:HORizontal:STEP(?)	3-47
:SENSe:CORRection:MDELay:VERTical(?)	3-48
:SENSe:CORRection:MDELay:VERTical:STEP(?)	3-49
:SOURce Commands	3-51
Command Tree	3-51
:SOURce:MVIDeo:AVIDeo(?)	3-52
:SOURce:MVIDeo:AVIDeo:STEP(?)	3-53
:SOURce:MVIDeo:PB(?)	3-54
:SOURce:MVIDeo:PB:STEP(?)	3-55
:SOURce:MVIDeo:CHRoma:AMPLitude(?)	3-56
:SOURce:MVIDeo:CHRoma:AMPLitude:STEP(?)	3-57
:SOURce:MVIDeo:LUMinance(?)	3-58
:SOURce:MVIDeo:LUMinance:STEP(?)	3-59
:SOURce:MVIDeo:PR(?)	3-60
:SOURce:MVIDeo:PR:STEP(?)	3-61
:SOURce:MVIDeo:TIMEbase(?)	3-62

:SOURce:MVIDeo:TIMEbase:STEP(?)	3-63
---------------------------------------	------

Appendices

Appendix A: Specifications	A-1
Appendix B: SCPI Conformance Information	B-1
Service Safety Summary	S-1
Appendix C: Installation	C-1
Preventing Component Damage	C-1
Module Installation	C-2
Hardware Installation	C-2
Signal Set Installation	C-6
Signal Backup and Module Removal	C-8
Module Removal	C-8

Glossary and Index

List of Figures

Figure 2–1: Menu structure for the HDVG1 Generator module	2–1
Figure 3–1: Example of SCPI subsystem hierarchy tree	3–4
Figure C–1: Rear panel slot numbering	C–2
Figure C–2: Top cover removal	C–3
Figure C–3: Removing the rear panel	C–4
Figure C–4: Module flange	C–4
Figure C–5: Installing the module	C–5
Figure C–6: Top screw	C–6

List of Tables

Table 1–1: Standard and Optional Accessories	1–2
Table 3–1: :MMEMory Commands	3–5
Table 3–2: :OUTPut Commands	3–6
Table 3–3: :SENSe Commands	3–7
Table 3–4: :SOURce Commands	3–7
Table A–1: Electrical specifications	A–1
Table A–2: Certifications and compliances	A–2
Table B–1: SCPI Conformance Information	B–1
Table C–1: Module slot assignments	C–2

General Safety Summary

Review the following safety precautions to avoid injury and prevent damage to this product or any products connected to it.

Only qualified personnel should perform service procedures.

To avoid potential hazards, use this product only as specified.

Injury Precautions

Avoid Electric Overload. To avoid electric shock or fire hazard, do not apply a voltage to a terminal that is outside the range specified for that terminal.

Product Damage Precautions

Do Not Operate With Suspected Failures. If you suspect there is damage to this product, have it inspected by qualified service personnel.

Symbols and Terms

Terms in this Manual. These terms may appear in this manual:



WARNING. Warning statements identify conditions or practices that could result in injury or loss of life.



CAUTION. Caution statements identify conditions or practices that could result in damage to this product or other property.

Terms on the Product. These terms may appear on the product:

DANGER indicates an injury hazard immediately accessible as you read the marking.

WARNING indicates an injury hazard not immediately accessible as you read the marking.

CAUTION indicates a hazard to property including the product.

Symbols on the Product. The following symbols may appear on the product:



DANGER
High Voltage



Protective Ground
(Earth) Terminal



ATTENTION
Refer to Manual



Double
Insulated

**Certifications and
Compliances**

Refer to the specifications section for a listing of certifications and compliances that apply to this product.

Preface

This manual documents the capabilities, specifications, operation, and installation of the HDVG1 Generator module.

About This Manual

This manual is composed of the following sections:

- *Getting Started* contains product description, incoming inspection procedure, accessories list, and signal set installation procedure.
- *Operating Basics* tells how to control the HDVG1 Generator module through the windowed menu interface in conjunction with the front panel.
- *Syntax and Commands* defines the syntax used in command descriptions, list of all command subsystems, and describes all programming commands.
- *Appendices* provides additional information including the Specifications and hardware installation procedures.

Related Manuals

The following documents are also available.

- The *HDVG1 HDTV Digital Video Generator Service Manual* describes how to service the module. This optional manual must be ordered separately.
- The *TG 2000 Signal Generation Platform User Manual* describes how to use the TG 2000 Platform. It also contains information about SCPI commands, programming structure, and status and events for the platform. Some of this information applies to all generator modules, including the HDVG1 Generator module. This manual is a standard accessory to the TG 2000 Platform mainframe.
- The *TG 2000 Signal Generation Platform Service Manual* describes how to service the mainframe to the module level and provides general information about servicing generator modules. This optional manual must be ordered separately.
- A module user manual is included with each optional module. Contact your Tektronix Representative for list of the available generator and special function modules.

Contacting Tektronix

Product Support	<p>For questions about using Tektronix measurement products, call toll free in North America: 1-800-TEK-WIDE (1-800-835-9433 ext. 2400) 6:00 a.m. – 5:00 p.m. Pacific time</p> <p>Or contact us by e-mail: tm_app_supp@tek.com</p> <p>For product support outside of North America, contact your local Tektronix distributor or sales office.</p>
Service Support	<p>Tektronix offers extended warranty and calibration programs as options on many products. Contact your local Tektronix distributor or sales office.</p> <p>For a listing of worldwide service centers, visit our web site.</p>
For other information	<p>In North America: 1-800-TEK-WIDE (1-800-835-9433) An operator will direct your call.</p>
To write us	<p>Tektronix, Inc. P.O. Box 1000 Wilsonville, OR 97070-1000 USA</p>
Website	<p>Tektronix.com</p>

Getting Started

This section contains the following information:

- Product description
- Accessories
- Option
- Functional Check

Product Description

The HDVG1 HDTV Digital Video Generator module is designed to be installed in the TG2000 Signal Generation Platform. The TG2000 Platform must be running version 2.0 or later firmware.

The module is an HDTV test signal generator which provides 1.485 Gb/s serial digital video signals in various formats. The module contains the following features:

- Produces custom test signals using SDP2000 software package
- Three serial digital video outputs
- Signal parameters such as active video gain and chroma/luma gain are adjustable in real-time from the front panel.
- Rear-panel trigger output, used to trigger an oscilloscope or other video equipment
- Overlay of circles, text, or logo on the video signal
- Up to 8 channels of Embedded Audio
- Full remote control using GPIB or RS-232C interface

The module can generate video signals with 24 (or 20) bit embedded digital audio with a sample rate of 48 kHz. Multiple user-selectable frequencies and amplitudes are available with channel and status independence.

The following audio frequencies are supported.

Silence	400 Hz	1500 Hz	4800 Hz
50 Hz	500 Hz	1600 Hz	6000 Hz
100 Hz	600 Hz	2000 Hz	8000 Hz
150 Hz	750 Hz	2400 Hz	9600 Hz
200 Hz	800 Hz	3000 Hz	12000 Hz
250 Hz	1000 Hz	3200 Hz	16000 Hz
300 Hz	1200 Hz	4000 Hz	

The amplitude or time base offset parameters can be adjusted using the procedure for *Video Parameters* on page 2–8. Several amplitude parameters of the signal can be adjusted such as luminance amplitude and chrominance gain.

The underlying time base used to generate signals can also be adjusted. When this parameter is adjusted, it adjusts every component of the active video signal, such as line length and rise time. The signal also becomes unframed; it has no phase relationship with the genlock input (AGL1 Generator module). Two modules with the same time base offset value are not necessarily framed together.

Accessories

Table 1–1 lists the standard and optional accessories for the HDVG1 Generator module.

Table 1–1: Standard and Optional Accessories

Accessory	Type of Accessory	Part Number
HDVG1 HDTV Digital Video Generator User Manual	Standard	071-0593-XX
HDVG1 Test Signal Disk	Standard	063-3253-XX
T-10 Torx Tip	Standard	003-1604-XX
Screws (2 ea.)	Standard	211-0725-XX
Certificate of Calibration	Standard	-----

Table 1-1: Standard and Optional Accessories (Cont.)

Accessory	Type of Accessory	Part Number
HDVG1 HDTV Digital Video Generator Service Manual	Optional	071-0594-XX
Test Data Report	Optional	-----

Option

This subsection describes the option available for the HDVG1 Generator module. The following option is available:

Option D1 (Test data report)

Option D1 (Test Data Report)

A calibration test data report will be provided with the HDVG1 Generator module when this option is specified.

Functional Check

The following procedure determines whether the module is operating correctly. If you are not familiar with the operation of the module, it may be helpful to refer to Figure 2-1 on page 2-1 while performing these procedures.

Required Equipment

For this procedure, you will need a digital television waveform monitor. This procedure was created using the Sony/Tektronix WFM1125 Digital Television Waveform Monitor.

Procedure

1. Install the module into the TG 2000 Platform mainframe using the installation procedures beginning on page C-2.
2. Power on the TG 2000 Signal Generation Platform. The platform runs a self test on all modules.
3. To determine if the self test was successful, push the **Module** button. Check the display for the icon that represents the HDVG1 Generator module that you are inspecting.
4. Install signal sets into the module using the procedures on page C-6. Select signal formats that are compatible with your digital television waveform monitor. (If another HDVG1 module is already installed, you do not need to install signal sets.)

5. Push the Modules button and touch the **HDVG1** icon on the display.
6. Select a signal set and a test signal.
7. Connect **Output 1** to the digital television waveform monitor.
8. Adjust the digital television waveform monitor to view the signal.
9. Check that the signal appears as expected. For example, if you selected a color bar signal in step 6, check that the color bar signal appears.

Functional Overview

This section provides an overview of the HDVG1 Generator module. If you are not familiar with the operation of the TG 2000 Signal Generation Platform, refer to the *TG 2000 Signal Generation Platform User Manual* before reading this section.

Figure 2–1 shows the menu structure for basic module operations.

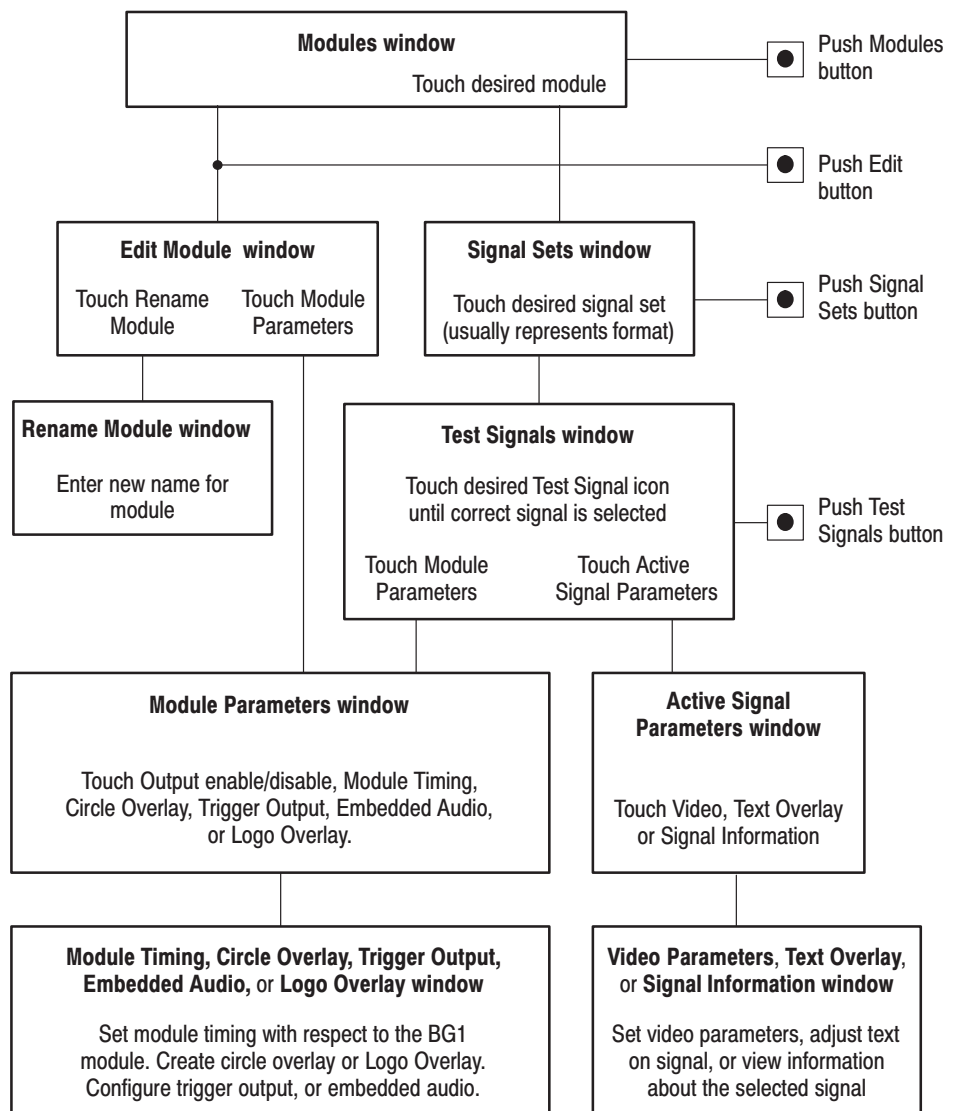

Figure 2–1: Menu structure for the HDVG1 Generator module

Outputs The HDVG1 Generator module has four outputs: three serial outputs and one trigger output.

Serial Outputs. Outputs 1, 2 and 3 are serial signal outputs (BNC).

Trigger Output. The trigger output (BNC) can be used to trigger an oscilloscope or other video equipment.

Online Help Push the front-panel **HELP** button to display a help window. The help window describes the window you were using when you pushed **HELP**.

Operating Procedures

This section is organized into the following main topics:

- Power on the mainframe and select the module
- Select the output signal
- Active signal parameters
- Module parameters

Refer to Figure 2-1 on page 2-1 for the menu structure.

Power On and Select the Module

After the module is installed in the mainframe, and the mainframe is installed in the rack or other location where it will be used, power on the mainframe, and select the module by following these steps:

1. Set the rear-panel power switch to the **ON** position.
2. Press the front-panel **POWER** switch if necessary.
3. Wait for a few seconds as the mainframe executes confidence tests on the mainframe and modules. Check for any error messages that might appear.
4. When self tests are complete, the instrument displays icons representing the generator modules. If an installed module is not represented, refer to *Troubleshooting* in the *HDVG1 HDTV Digital Video Generator Service Manual*.

NOTE. The illustrations in these procedures show the factory default name (HDVG1:X where X represents the slot number in which the module is installed). However, because you can rename the module, your icons may display a different name. Refer to the TG 2000 Signal Generation Platform User Manual for information about editing the module name.

5. Since you have just powered on the platform, the Modules window is displayed. To open this window at other times, push the **Modules** button.

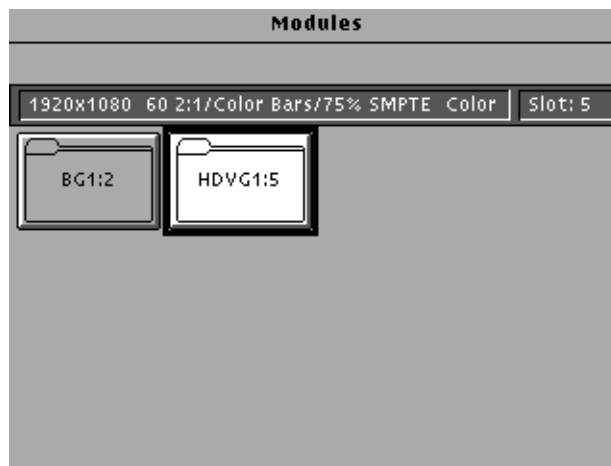

6. Touch the module icon on the display (or push the **Signal Sets** button if the desired icon is already highlighted). The installed signal sets for the module appear. Selections you make after this will pertain to the HDVG1 Generator module.

Select the Output Signal

The output signal is supplied on the three rear-panel serial outputs. Use the following procedure to select the module's output test signal. You can select any of the HDVG1 signals that are loaded in your instrument.

1. Push the **Signal Sets** button to open the window shown below. Check that there is an icon for each installed signal set. If your signal sets are not installed, refer to *Signal Set Installation* on page C-6.

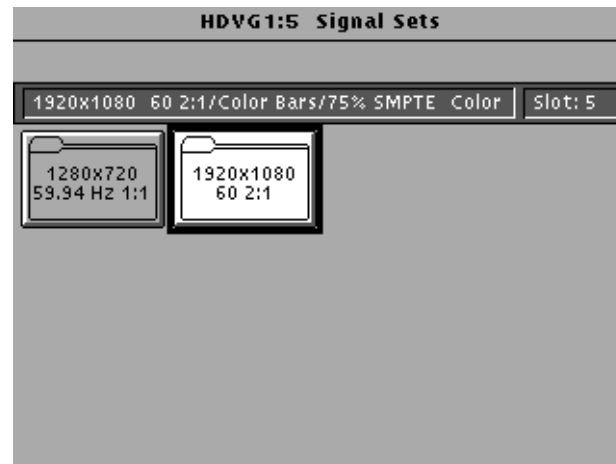

2. Touch the desired signal set on the display. The Test Signals window for the selected signal set appears. In the following example, 1920X1080 60 2:1 is selected.



3. Each test signal icon in the Test Signals window represents one or more signals that the module can generate. In this example, the Color Bar test signal icon is selected, and the 75 % SMPTE Color Bars signal is being generated.
4. To change to another Color Bar signal, touch the **Color Bar** repeatedly to browse through all available signals. You can also display the complete list of test signals available under a selected test-signal icon by touching the list box or by rotating the Navigation knob, and then select a signal by pressing the front-panel **Select** button.
5. To change to a different signal type, touch the corresponding icon on the display. Then select the signal as shown in step 4.
6. To select the output signal using the List window, display the list of test signals by pushing the front-panel **List** button. Use the Navigation arrow keys to highlight the module and signal, and then push the **Select** button.

Active Signal Parameters

The following procedures discuss windows that are accessed through the Active Signal Parameters window, shown below. Changes that you make to parameters in any of these windows affect only the active signal.

To enter the Active Signal Parameters window for the HDVG1 Generator module, follow these steps:

1. Select the module, if not already selected.
2. Push the **Test Signals** button.
3. Touch **Active Signal Parameters** at the bottom of the screen. The Active Signal Parameters window appears, as shown below.

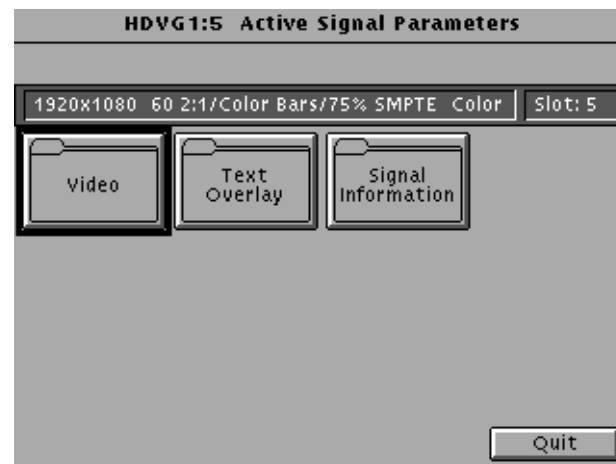

Video Parameters

You can adjust the signal parameters of the currently selected (active) test signal by modifying the parameters and then saving the signal with a new name. There are no factory defaults. Factory signals may be re-installed, if needed.

NOTE. *To modify and save a Tektronix generated signal, you must rename it. When you rename and save a signal, both the original and the modified signals are saved.*

To change the signal parameters, follow these steps:

1. In the Active Signal Parameters window, shown on page 2-7, touch **Video**.
2. The Video Parameters window opens, as shown below. (Different signals may display a different list in this window.) Use the Navigation arrow keys to select the parameter you want to change. The Time Base Offset parameter is described on page 1-2.

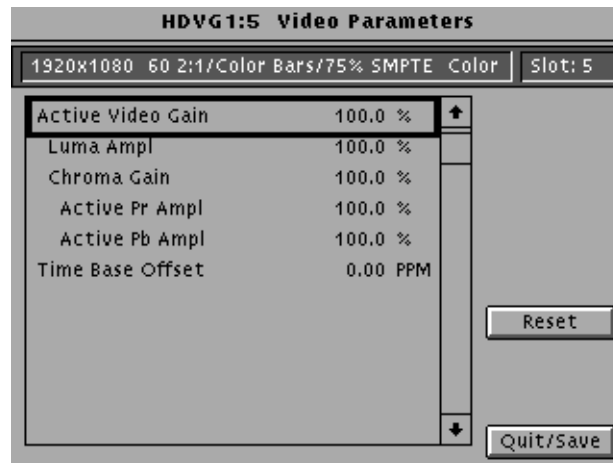

3. Enter a value using the knob or keypad.
4. If you want to reset all the parameters to their previously saved value, touch **Reset**.

NOTE. *If you change the value for Active Video Gain, the Luma Ampl value, Chroma Gain value, Active Pr Ampl value, and Active Pb Ampl value also change.*

5. Press **Quit/Save**. A dialog box appears.

NOTE. If you modify any signal that was shipped on the factory disks, the platform adds an underscore to the front of the name.

6. Touch **Save As** to save and rename the test signal. A text entry window appears as shown in the following illustration. The platform suggests a new test signal name for you by adding an underscore to the front of the current name.

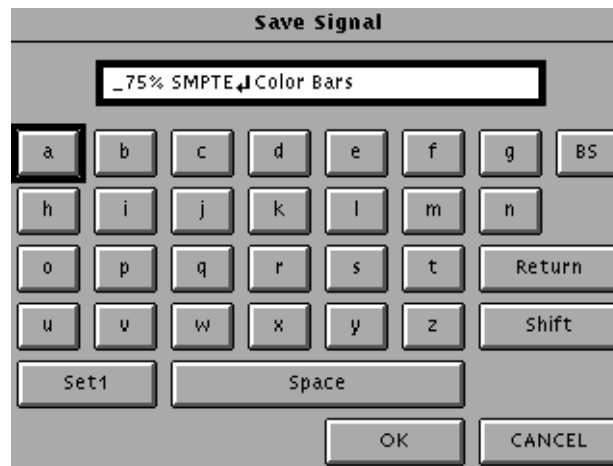

7. To use the suggested name, touch **OK**.
8. If you want a different name, do the following:
 - a. Delete the displayed name using the **BS** key, and then enter new text. (You cannot backspace over an underscore character.)
 - b. Touch **Set1** or **Set2** to provide additional sets of characters.
 - c. Touch **OK** when text is complete.
9. Touch **Quit/Save** to exit the window.

Text Overlay

You can enter text that overlays your displayed test signal. When turning text on or off, you are turning text on or off for all test signals that have overlaid text, even though the text may be different for each signal. Touching **Reset** returns the text, horizontal and vertical to previously saved values.

To enter and position text, follow these steps:

1. In the Active Signal Parameters window, shown on page 2-7, touch **Text Overlay** to enter the Signal Text window. The Signal Text window is shown in the following illustration.

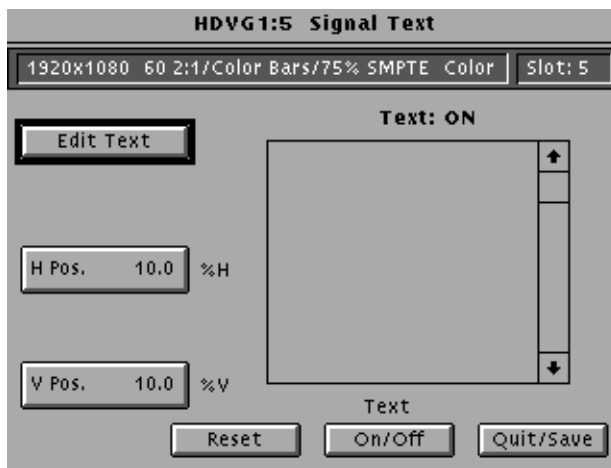

2. Touch **Edit Text** to enter the text entry window as shown in the following illustration.

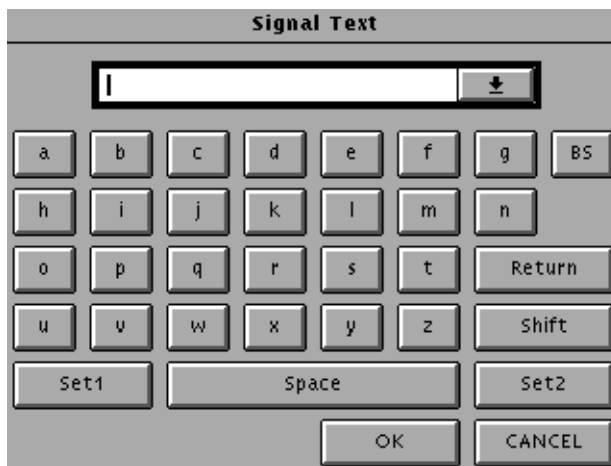

3. Enter text as follows:
 - a. Touch the desired letters on the display.
 - b. Touch **Return** if you want to enter a new line.
 - c. Touch the list box at the top of the window to see all the text entered.
 - d. Touch **OK** when text entry is complete. The Signal Text Overlay menu returns.
4. Touch **Text On/Off** to display the text on your monitor. The Signal Text Overlay menu lists the text you previously entered, as shown in the following illustration.

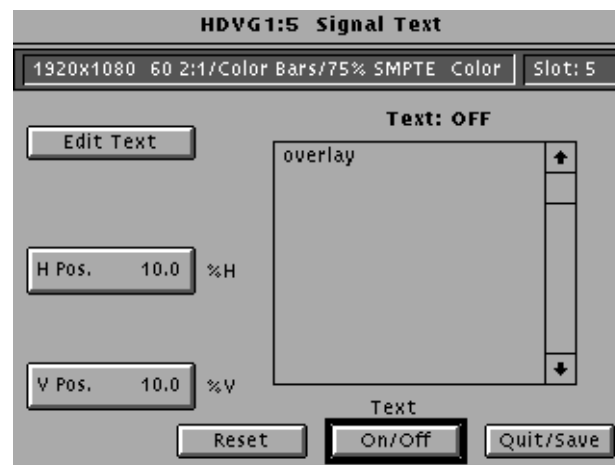

5. Touch **H Pos.**
6. Enter a value from the keypad or rotate the knob until the desired horizontal position is reached.
7. Touch **V Pos.**
8. Enter a value from the keypad or rotate the knob until the desired horizontal position is reached.
9. If you want to return the text, horizontal and vertical to previously saved value, touch **Reset**.
10. Touch **Quit/Save**. A dialog box appears.
 - a. If you touch **Save**, the modified test signal is saved with an underscore added to the front of the name.
 - b. If you touch **Save As**, a text entry window is displayed. Enter a new name for the signal.

Signal Information

You can view detailed information about the selected signal.

1. In the Active Signal Parameters window, shown on page 2–7, touch **Signal Information**.
2. View the signal information, as shown in the following illustration.

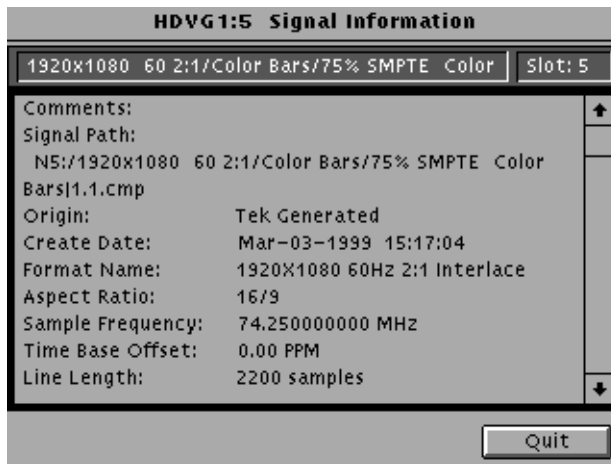

Module Parameters

The following procedures discuss windows that are accessed through the Module Parameters window, shown below. Changes that you make to parameters in any of these windows affect the entire module.

To enter the Module Parameters window for the HDVG1 Generator module, follow these steps:

1. Select the HDVG1 Generator module, if not already selected.
2. Push the **Test Signals** button.
3. Touch **Module Parameters** at the bottom of the screen. The Module Parameters window appears, as shown below.

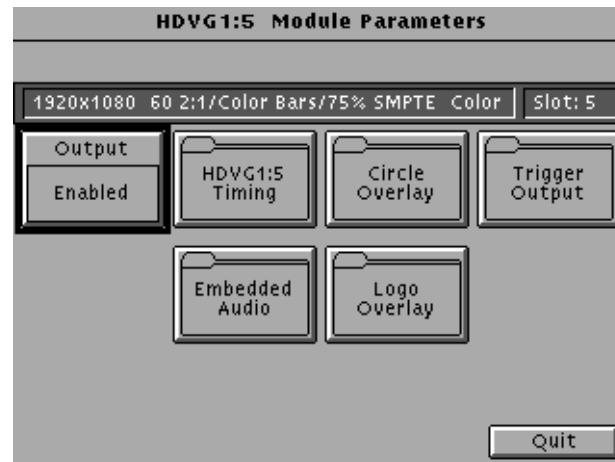

4. Another way to access this window is as follows:
 - a. Push the **Modules** button.
 - b. Ensure that the module is highlighted.
 - c. Push the **Edit** button.
 - d. Touch **Module Parameters**.

Circle Overlay

You can create a circle that is overlaid on the output test signal. The circle overlay parameters will affect all test signals from this module. Entered values are constant, regardless of which test signal or video standard you use.

To define a circle overlay, follow these steps:

1. In the Module Parameters window, shown on page 2–13, touch **Circle Overlay** to enter the **Circle Overlay** window. The Circle Overlay window is shown in the following illustration.



2. Touch **On/Off** to turn on the circle overlay.
3. Touch **Diam.**
4. Touch the Navigation knob or enter a value from the keypad. Rotating the knob changes the diameter by percentages of Active Picture Height (APH).
5. Touch **H Pos** and rotate the Navigation knob to move the circle horizontally by a percentage of APH.
6. Touch **V Pos** and rotate the Navigation knob to move the circle horizontally by a percentage of APH.
7. If you want to reset the values, touch **Reset All**. This will set the diameter, horizontal, and vertical to 90%, 0, and 0 respectively.
8. Touch **Quit** to exit the window.

Enable/Disable the Output Signal

If you disable the module output, it releases all system resources used by this module. To disable the module output, follow these steps:

1. Select the module, if not already selected.
2. Push the **Test Signals** button.

3. Touch **Module Parameters** at the bottom of the screen. The Module Parameters window (shown on page 2–13) appears.
4. Touch the **Output** icon to toggle the state of the module's output signal.
5. Touch **Quit** to exit.

Embedded Audio

You can turn embedded audio on or off, select which channel groups to enable, and which of the enabled groups to send first. You can also adjust the frequency and amplitude of the embedded audio signal. Changes you make affect all signals for this module.

1. In the Module Parameters window, shown on page 2–13, touch **Embedded Audio** to enter the Embedded Audio window shown below.



2. To enable the embedded audio, perform the following steps:
 - a. Touch the **Audio** icon to turn on the embedded audio.
 - b. Touch the **Number of Groups Enabled** list box and use the navigation arrow to select the number of groups you want to enable (1 or 2).
 - c. Push the **Select** button.
 - d. Touch the **Starting Group** list box and use the navigation arrow to select the group that will be sent first.
 - e. Push the **Select** button.
3. To configure the channel parameters, perform the following steps:
 - a. Touch the icon corresponding to the group that you want to configure. The Audio Groups window will appear. The following illustration shows an audio group window for Audio Group 1 or 3.

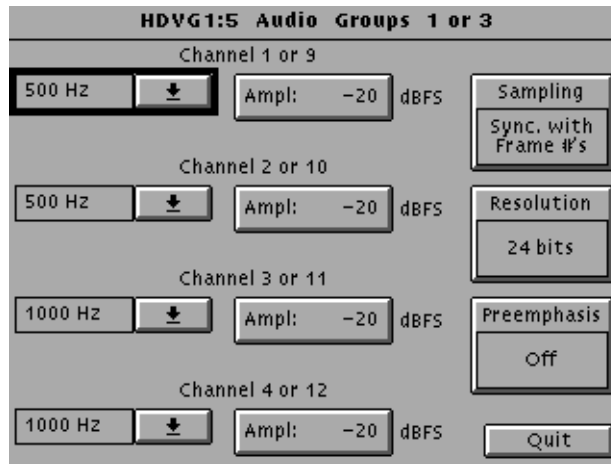

- b. Touch the list box corresponding to the channel for which you want to change the frequency. A list window appears for you to select the desired frequency.
- c. Select the desired frequency using the cursor keys and the **Select** button.
- d. Perform steps b and c for each channel you want to adjust.
- e. To change the amplitude, touch **Ampl:** next to the desired channel and enter a value using the keypad. Selections range from -60 to 0 decibels full scale (dBFS).
- f. To change the sampling alignment status bit in the embedded audio stream, touch **Sampling** icon until the desired selection Async (asynchronous), Sync w/o Frame #s (synchronous without frame numbers), or Sync with Frame #s (Synchronous with frame numbers) is displayed.
- g. To change the sample bits, touch **Resolution** icon until the desired selection 20 bits or 24 bits is displayed.
- h. To change the Preemphasis status bit in the embedded audio stream, touch the **Preemphasis** icon until the desired selection Off, CD, or CCITT is displayed.

Logo Overlay

You can provide a logo that is overlaid on the output test signal. The logo overlay parameters will affect all test signals from this module. Entered values are constant, regardless of which test signal or video standard you use.

To define a logo overlay, follow these steps:

1. In the Module Parameters window, shown on page 2–13, touch **Logo Overlay** to enter the **Logo Overlay** window. The Logo Overlay window is shown in the following illustration.



2. Touch **On/Off** to turn on the logo overlay.
3. Touch the **Select Logo** list box and use the Navigation arrows to select the logo file you want to use.
4. If the file you want to use does not appear in the list, you can add the logo file to the list using Add Logo from Disk function. Refer to *Add Logo from Disk* on page 2–20 .
5. Touch **H Pos** and rotate the Navigation knob to move the logo horizontally by a percentage of APH.
6. Touch **V Pos** and rotate the Navigation knob to move the logo vertically by a percentage of APH.
7. If you want to reset the values touch **Reset**. This will set the horizontal and vertical to 0.
8. Touch **Quit** to exit the window.

Logo File Utilities

You can save logos to a disk, add logos from a disk, and delete logos from the module using the Logo File Utilities window.

To enter the **Logo File Utilities** window, touch **File Utils** in the Logo Overlay window, shown on page 2-16. The Logo File Utilities window is shown in the following illustration.



Save Logo to Disk. From the Save Logo to Disk window you can save logos to a disk. You should save all logos in the module to disk before removing the module. Modules lose their memory after 30 seconds out of the mainframe.

To save logos to a disk, follow these steps:

1. In the Logo File Utilities window shown above, touch **Save Logo to Disk** to enter the **Save Logo to Disk** window. The Save Logo to Disk window is shown in the following illustration.



2. Insert a preformatted floppy disk into the drive. Ensure that the disk is not write protected.
3. Touch **Select Source**. The Save Logo to Disk–Select Source window appears, as shown below.



4. Select the logos you want to save to a disk file.
5. Touch **Quit/Save** to exit the window.
6. In the Save Logo to Disk window, shown on page 2–18, touch **Select Destination**. The Save Logo to Disk–Select Destination window appears, as shown below.

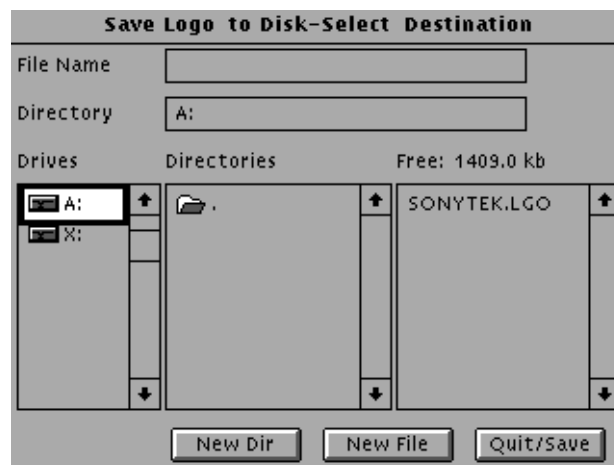

7. Use the **New Dir** selection to create a directory on the disk if you like. Otherwise select **New File** and give the logo file a name.
8. With the Source and Destination entered you are ready to save the logos to the disk. Touch **Quit/Save** to begin the save process.

Saving a logo to disk takes a brief time depending on the size of the logo file.

Add Logo from Disk. From the Add Logo from Disk window you can add logos from a disk file. Logos are stored in the same NVRAM space as the test signals.

NOTE. To create new logos see the *LOGOGEN* program in the *SDP2000*

To add a logo to the module, follow these steps.

1. In the Logo File Utilities window shown on page 2–18, touch **Add Logo from Disk** to enter the **Add Logo from Disk** window. The Add Logo from Disk window is shown in the following illustration.



2. Insert the disk containing the logo file into the drive.
3. Select the logo file that you want to load. When you have chosen, touch **Start/Load**.
4. Touch **Quit** to exit the window.

Delete Logo. From the Delete Logo window you can remove logos from the HDVG1 module. You may want to delete logos to make room for new logos.

To delete logos from the module, follow these steps:

1. In the Logo File Utilities window shown on page 2–18, touch **Delete Logo** to enter the **Delete Logo** window. The Delete Logo window is shown in the following illustration.

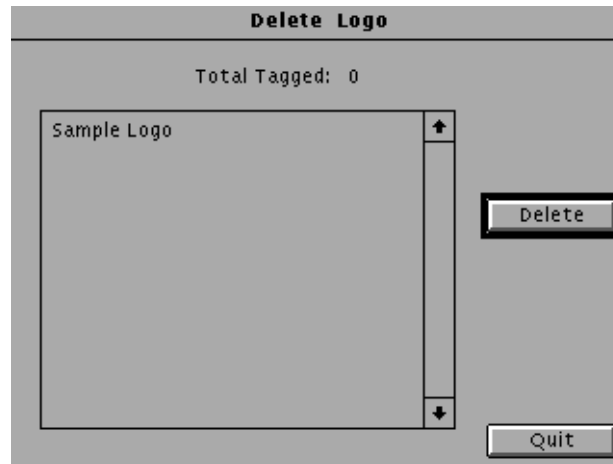

2. Select the logo you wish to delete.
3. Touch the **Delete** to remove the selected logo from the module.
4. Touch **Quit** to exit the window.

Timing

You can set the horizontal and vertical timing of this module with respect to the BG1 Generator module, when they are running at the same frame rate. Changes you make to timing affect all signals for the HDVG1 Generator module as well as the relative timing between the HDVG1 and BG1 Generator modules.

NOTE. Time zero is when the HDVG1 Generator module timing is the same as the BG1 Generator module, and they are running at the same frame rate

1. In the Module Parameters window, shown on page 2–13, touch the module timing icon. The Timing window appears, as shown in the following illustration.



2. Touch **Vertical** on the display. The default setting is 0 lines.
3. Rotate the navigation knob counterclockwise to advance the timing or clockwise to delay the timing. Increments are equal to a full cycle of the clock.
4. Touch **Horizontal**. The default setting is 0.000 μ sec.
5. Rotate the navigation knob counterclockwise to advance the timing or clockwise to delay the timing. Increments are equal to a full cycle of the clock. You can also enter values from the keypad and push the **Select** button.

NOTE. When more than one line of advance or delay is entered, the Vertical Timing is advanced or delayed.

6. Touch **Reset All** if you want to return horizontal and vertical timing to the defaults. Touch **Quit** to exit the window.

Trigger Output

You can generate three types of Trigger signals to the rear panel BNC.

1. In the Module Parameters window, shown on page 2–13, touch **Trigger** to enter the Trigger window, shown below.

NOTE. Triggers are active throughout the line. However, cursors are only active during active video.

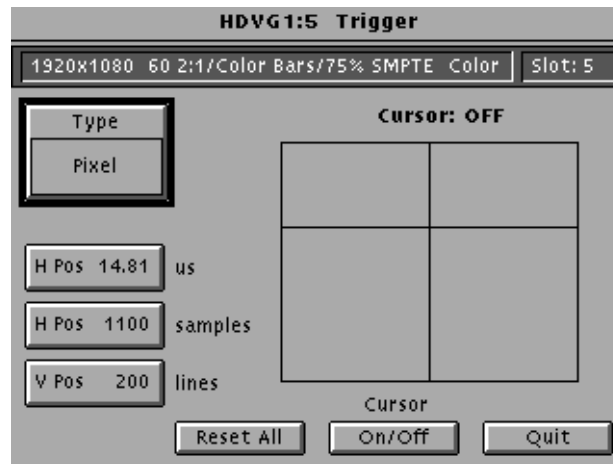

2. Turn on the cursor by touching the **On/Off** on the display. A cursor provides line and pixel selection anywhere within the frame.
3. Touch **Type** on the display until the desired type of trigger is displayed:
 - Horizontal (one trigger pulse per line at location entered)
 - Vertical (one trigger pulse per color frame at beginning of line entered)
 - Pixel (one trigger pulse per color frame at intersection of horizontal and vertical trigger)
4. If the type is horizontal or pixel, touch **HPos us** (to adjust horizontal position by time) or **HPos samples** (to adjust horizontal position by samples). Rotate the **Navigation** knob until the desired position is reached, or enter a value using the keypad and push enter.
5. If the type is vertical or pixel, touch **VPos** and rotate the **Navigation** knob until the desired line is reached. You can also enter a value using the keypad.
6. Touch **Reset All** if you want to set all the parameters to the default settings (H Pos to zero and V Pos to 1).
7. Touch **Quit** to exit the window.



Syntax and Commands

Syntax

This section contains information on the Standard Commands for Programmable Instruments (SCPI) and the programming structure you can use to program your HDVG1 Generator module.

Programming Model

Specific conditions must exist before programming commands will affect the test signal generated by a module.

Addressing Module Test Signals

The following two steps must be performed before the test module will respond to signal parameter commands.

1. Select the module using the `:INSTRument:SElect` command before executing any commands. Many of the commands used by the HDVG1 module are shared by several modules and will be accepted without a reported error.
2. Enable the module using the `:OUTPut:STATe ON` command. The output state of the module must be enabled before test signal parameters can be changed.

Command Arguments

Many commands will accept either string or numeric arguments. For example: a boolean argument can either be "1" or "ON".

Signal parameter commands that have a `:STEP` node can accept either a numeric value or they can accept a string argument that refers to the `:STEP` increment.

Signal parameter commands with a `:STEP` node will accept the following strings in addition to a numeric value:

UP. Use this argument to increase the parameter value one increment as defined by the `:STEP` value.

DOWN. Use this argument to decrease the parameter value one increment as defined by the `:STEP` value.

MINimum. Use this argument to set the parameter value to the minimum acceptable value.

MAXimum. Use this argument to set the parameter value to the maximum acceptable value.

DEFault. Use this argument to set the parameter value to the default value.

Query Arguments

If you send a query with no argument, the response is the current value. You can also use MINimum, MAXimum, and DEFault as arguments for queries whose command form can use these arguments (refer to the command syntax for the specific command). Instead of returning the current value, queries using these arguments return the following information:

MINimum. Return the minimum acceptable value.

MAXimum. Return the maximum acceptable value.

DEFault. Return the default value.

Argument Example

The following example demonstrates the effect of each of the arguments when used with a step value.

1. `:INSTRUMENT:SELECT "HDVG1:#"` selects the digital video generator module located in the slot number indicated by the “#” symbol.
2. `:OUTPUT:STATE ON` enables the module and displays the loaded test signal.
3. `:OUTPUT:CIRCLE:STATE ON` displays a circle on the video display.

NOTE. `:OUTPUT:CIRCLE:DIAMETER` uses an argument that is the percent of picture height.

4. `:OUTPUT:CIRCLE:DIAMETER DEFAULT` sets the circle diameter to 90 percent of the screen height.
5. `:OUTPUT:CIRCLE:DIAMETER:STEP 10` sets the step increment to 10 percent.
6. `:OUTPUT:CIRCLE:DIAMETER DOWN` changes the circle diameter to 80 percent of the screen height.
7. `:OUTPUT:CIRCLE:DIAMETER 50` changes the circle diameter to 50 percent of the screen height.

8. :OUTPut:CIRClE:DIAMeter MAXimum changes the circle diameter to 100 percent of the screen height.
9. :OUTPut:CIRClE:DIAMeter MINimum changes the circle diameter to 0 percent of the screen height.
10. :OUTPut:CIRClE:DIAMeter UP changes the circle diameter to 10 percent of the screen height.
11. :OUTPut:CIRClE:DIAMeter? MAXimum queries the maximum circle diameter (not the current diameter). The query returns the value of 100 percent, which is the maximum circle diameter allowable.

SCPI Commands and Queries

SCPI is a standard created by a consortium that provides guidelines for remote programming of instruments. These guidelines provide a consistent programming environment for instrument control and data transfer. This environment uses defined programming messages, instrument responses, and data format across all SCPI instruments, regardless of manufacturer. The HDVG1 Generator module uses a command language based on the SCPI standard.

The SCPI language is based on a hierarchical or tree structure (see Figure 3–1) that represents a subsystem. The top level of the tree is the root node; it is followed by one or more lower-level nodes.

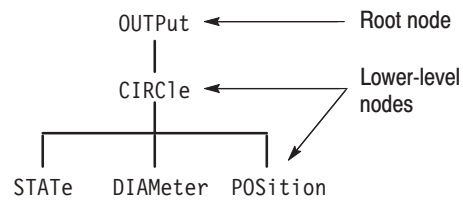

Figure 3-1: Example of SCPI subsystem hierarchy

You can create commands and queries from these subsystem hierarchy trees. Commands specify actions for the instrument to perform. Queries return measurement data and information about parameter settings.

For more information on SCPI commands, programming structure, and TG 2000 Signal Generation Platform status and events, refer to the *TG 2000 Signal Generation Platform User Manual*.

Functional Command Groups

This section describes the commands in general categories. Commands to the module are divided into the following groups:

- MMEMory (see *TG2000 Signal Generation Platform User Manual*)
- OUTPut
- SENSE
- SOURce

Items followed by question marks are queries; items without question marks are commands. Some items in this section have a question mark in parentheses (?) in the command header section; this indicates that the item can be both a command and a query.

MMEMory

Five MMEMory commands are listed here for your reference. You can use these to set and query the output test signal and logo for the module. Detailed information for using these commands (as well as other commands that can be used with the entire platform) are located in the *TG2000 Signal Generation Platform User Manual*.

Table 3-1: :MMEMory Commands

Command	Description
:MMEMory:LOAD:LOGO	Load a logo into a module and identify that logo as the active logo for that module
:MMEMory:LOGO:CATalog?	List logos for the current module
:MMEMory:STORE:LOGO	Copy a logo data to a file
:MMEMory:LOAD:SIGNal	Load a signal into a module and identify that signal as the active signal (output signal) for that module
:MMEMory:SIGNal:ACTive?	List the active signal (output signal) for a module

Output

Use these commands to select the output characteristics of the module.

Table 3-2: :OUTPut Commands

Command	Description
:OUTPut:STATe(?)	Set or query module output
:OUTPut:CIRClE:STATe(?)	Set or query circle
:OUTPut:CIRClE:DIAMeter(?)	Set or query circle diameter
:OUTPut:CIRClE:POSItion:HORizontal(?)	Set or query circle horizontal position
:OUTPut:CIRClE:POSItion:VERTical(?)	Set or query circle vertical position
:OUTPut:CIRClE:RESet	Reset all circle parameters
:OUTput:EAUDio:STATe(?)	Set or query embedded audio
:OUTput:EAUDio:CHANnel<n>:STATe(?)	Set or query channel audio control packet inactive state
:OUTput:EAUDio:CHANnel<n>:AMPLitude(?)	Set or query channel audio amplitude
:OUTput:EAUDio:CHANnel<n>:FREQuency(?)	Set or query channel audio frequency
:OUTput:EAUDio:GROup<n>:PREEmphasis(?)	Set or query channel audio preemphasis
:OUTput:EAUDio:GROup<n>:NBITs(?)	Set or query channel audio sample bits
:OUTput:EAUDio:GROup<n>:SAMPLIng(?)	Set or query audio sampling alignment
:OUTput:EAUDio:NGROups(?)	Set or query channel audio state
:OUTput:EAUDio:SGROups(?)	Set or query the starting group for embedded audio
:OUTPut:LOGO:STATe(?)	Set or query logo
:OUTPut:LOGO:POSItion:HORizontal(?)	Set or query logo horizontal position
:OUTPut:LOGO:POSItion:VERTical(?)	Set or query logo vertical position
:OUTPut:LOGO:RESet	Reset logo parameters
:OUTPut:LOGO:SElect(?)	Select or query current logo
:OUTPut:TEXT:STATe(?)	Set or query text
:OUTPut:TEXT:DATA(?)	Set or query current text string
:OUTPut:TEXT:POSItion:HORizontal(?)	Set or query text horizontal position
:OUTPut:TEXT:POSItion:VERTical(?)	Set or query text vertical position
:OUTPut:TEXT:RESet	Reset text parameters
:OUTPut:TRIGger:TYPE(?)	Set or query trigger type
:OUTPut:TRIGger:CURSor:STATe(?)	Set or query trigger cursor
:OUTPut:TRIGger:POSItion:HORizontal(?)	Set or query trigger horizontal position
:OUTPut:TRIGger:POSItion:HORizontal:STEP(?)	Set or query trigger horizontal position step size
:OUTPut:TRIGger:POSItion:HORizontal:SAMPlE(?)	Set or query trigger horizontal position in samples
:OUTPut:TRIGger:POSItion:HORizontal:SAMPlE:STEP(?)	Set or query trigger horizontal position sample step size

Table 3-2: :OUTPut Commands (Cont.)

Command	Description
:OUTPut:TRIGger:POSition:VERTical(?)	Set or query trigger vertical position
:OUTPut:TRIGger:POSition:VERTical:STEP(?)	Set or query trigger vertical position step size
:OUTPut:TRIGger:RESet	Reset trigger parameters

Sense

Use these commands to adjust the module timing.

Table 3-3: :SENSe Commands

Command	Description
:SENSe:CORRection:MDElay:HORizontal(?)	Set or query horizontal time delay
:SENSe:CORRection:MDElay:HORizontal:STEP(?)	Set or query horizontal step size
:SENSe:CORRection:MDElay:VERTical(?)	Set or query vertical time delay
:SENSe:CORRection:MDElay:VERTical:STEP(?)	Set or query vertical step size

Source

Use these commands to define the signal parameters for the module.

Table 3-4: :SOURce Commands

Command	Description
:SOURce:MVIDeo:AVIDeo(?)	Set or query active video amplitude
:SOURce:MVIDeo:AVIDeo:STEP(?)	Set or query active video amplitude step size
:SOURce:MVIDeo:CHRoma:AMPLitude(?)	Set or query channel chroma amplitude
:SOURce:MVIDeo:CHRoma:AMPLitude:STEP(?)	Set or query channel chroma amplitude step size
:SOURce:MVIDeo:LUMinance(?)	Set or query channel luminance amplitude
:SOURce:MVIDeo:LUMinance:STEP(?)	Set or query channel luminance amplitude step size
:SOURce:MVIDeo:PB(?)	Set or query channel PB component amplitude
:SOURce:MVIDeo:PB:STEP(?)	Set or query channel PB step size
:SOURce:MVIDeo:PR(?)	Set or query channel PR component amplitude
:SOURce:MVIDeo:PR:STEP(?)	Set or query channel PR step size
:SOURce:MVIDeo:TIMEbase(?)	Set or query sync module time base
:SOURce:MVIDeo:TIMEbase:STEP(?)	Set or query module time base step size

:OUTPut Commands

Use these commands to enable the actual output of the module. This subsystem also controls the embedded audio, circle overlay, logo overlay, and module trigger.

NOTE. *The module must be selected with the INSTRument:SElect command prior to using these commands.*

Command Tree

```
:OUTPut
:STATe                <boolean>
:CIRClE
:STATe                <boolean>
:DIAMeter            <numeric_value>
:POSition
:  HORizontal        <numeric_value>
:  VERTical          <numeric_value>
:RESet
:EAUDio
:STATe                <boolean>
:CHANnel<n>
:  STATE            <boolean>
:  AMPLitude        <numeric_value>
:  FREQuency        <numeric_value>
:GRoup<n>
:  PREemphasis      <argument>
:  NBITS            <numeric_value>
:  SAMPLing         <argument>
:NGRoups              <numeric_value>
:SGRoup               <numeric_value>
:LOGO
:STATe                <boolean>
:POSition
:  HORizontal        <numeric_value>
:  VERTical          <numeric_value>
:RESet
:SElect               <string>
:TEXT
:STATe                <boolean>
:DATA                 <string>
:POSition
:  HORizontal        <numeric_value>
:  VERTical          <numeric_value>
:RESet
:TRIGer
:TYPE                 <argument>
:CURSor
:  STATE            <boolean>
:POSition
:  VERTical          <numeric_value>
:  STEP              <numeric_value>
:  HORizontal        <numeric_value>
:  STEP              <numeric_value>
:RESet
```

:OUTPut:STATe(?)

Use this command to set or query the state of the HDVG1 Generator module output signal.

Syntax :OUTPut:STATe <boolean>
:OUTPut:STATe?

Parameters

Command	Query response
<boolean> = ON or 1, OFF or 0	1, 0

Default Value ON

Errors and Events None

Dependencies None

Examples
Command: :OUTP:STAT ON
Query: :OUTP:STAT?
Response: 1

Related Commands None

:OUTPut:CIRClE:STATe(?)

Use this command to set or query the display of the circle overlay onto the video signal.

NOTE. *The settings of the circle overlay are independant of signal activity.*

Syntax :OUTPut:CIRClE:STATe <boolean>
:OUTPut:CIRClE:STATe?

Parameters	Command	Query response
	<boolean> = ON or 1, OFF or 0	1, 0

Default Value OFF

Errors and Events -200 Execution error
-141 Invalid character data

Dependencies None

Examples Command: :OUTP:CIRC:STAT 1
Query: :OUTP:CIRC:STAT?
Response: 1

Related Commands :OUTPut:CIRClE:POSition:VERTical,
:OUTPut:CIRClE:POSition:HORizontal

:OUTPut:CIRClE:DIAMeter(?)

Use this command to set or query the diameter of the displayed circle. The unit is percent of average picture height.

Syntax :OUTPut:CIRClE:DIAMeter <numeric_value>
:OUTPut:CIRClE:DIAMeter?

Parameters	Command	Query response
	<numeric_value> = <NRf> MIN, MAX, DEF	<NR2>

Default Value 90

Errors and Events -200 Execution error
-120 Numeric data error

Dependencies None

Examples
Command: :OUTP:CIRC:DIAM 75
Query: :OUTP:CIRC:DIAM?
Response: 75.0000

Related Commands :OUTPut:CIRClE:POSition:VERTical,
:OUTPut:CIRClE:POSition:HORizontal

:OUTPut:CIRClE:POSItion:HORizontal(?)

Use this command to set or query the horizontal position of the circle as it appears on the active signal. The unit is percent of average picture width.

Syntax :OUTPut:CIRClE:POSItion:HORizontal <numeric_value>
:OUTPut:CIRClE:POSItion:HORizontal?

Parameters	Command	Query response
	<numeric_value> = <NRf> MIN, MAX, DEF	<NR2>

Default Value 0

Errors and Events -200 Execution error
-120 Numeric data error

Dependencies None

Examples Command: :OUTP:CIRC:POS:HOR 35
Query: :OUTP:CIRC:POS:HOR?
Response: 35.0000

Related Commands :OUTPut:CIRClE:POSItion:VERTical

:OUTPut:CIRClE:POSItion:VERTical(?)

Use this command to set or query the vertical position of the circle as it appears on the active signal. The unit is percent of average picture height.

Syntax :OUTPut:CIRClE:POSItion:VERTical <numeric_value>
:OUTPut:CIRClE:POSItion:VERTical?

Parameters	Command	Query response
	<numeric_value> = <NRf> MIN, MAX, DEF	<NR2>

Default Value 0

Errors and Events -200 Execution error
-120 Numeric data error

Dependencies None

Examples
Command: :OUTP:CIRC:POS:VERT 35
Query: :OUTP:CIRC:POS:VERT?
Response: 35.0000

Related Commands :OUTPut:CIRClE:POSItion:HORizontal

:OUTPut:CIRClE:RESet

Use this command to reset the parameters of the circle overlay. There are no arguments.

Syntax :OUTPut:CIRClE:RESet

Parameters	Command	Query response
	None	None

Default Value Not applicable

Errors and Events -200 Execution error

Dependencies The HDVG1 Generator module must be enabled.

Examples Command: :OUTP:CIRC:RES

Related Commands :OUTPut:CIRClE

:OUTPut:EAUDio:STATe(?)

Use this command to set or query the embedded audio state.

Syntax :OUTPut:SERial:EAUDio:STATe <boolean>
:OUTPut:SERial:EAUDio:STATe?

Parameters

Command	Query response
<boolean> = ON or 1, OFF or 0	1, 0

Default Value ON

Errors and Events -200 Execution error
-141 Invalid character data

Dependencies None

Examples Command: :OUTP:EAUD:STAT ON
Query: :OUTP:EAUD:STAT?
Response: 1

Related Commands None

:OUTPut:EAUDio:CHANnel<n>:STATe(?)

Use this command to set or query the inactive state of the audio control packet for a specific embedded audio channel.

The <n> in the command represents the channel number. You can use any channel number from 1 through 8.

Syntax :OUTPut:SERial:EAUDio:CHANnel<n>:STATe <boolean>
:OUTPut:SERial:EAUDio:CHANnel<n>:STATe?

Parameters

Command	Query response
<boolean> = ON or 1, OFF or 0	1, 0

Default Value ON

Errors and Events -200 Execution error
-141 Invalid character data

Dependencies None

Examples Command: :OUTP:EAUD:CHAN2:STAT ON
Query: :OUTP:EAUD:CHAN2:STAT?
Response: 1

Related Commands None

:OUTPut:EAUDio:CHANnel<n>:AMPLitude(?)

Use this command to set or query the amplitude of a specific embedded audio channel. The unit is dBFS.

The <n> in the command represents the channel number. You can use any channel number from 1 through 8.

Syntax :OUTPut:EAUDio:CHANnel<n>:AMPLitude <numeric_value>
:OUTPut:EAUDio:CHANnel<n>:AMPLitude?

Parameters

Command	Query response
<numeric_value> = <NRf> -60 ≤ <NRf> ≤ -20	<NR2>

Default Value -20

Errors and Events -200 Execution error
-104 Data type error

Dependencies None

Examples
Command: :OUTP:EAUD:CHAN1:AMPL 10
Query: :OUTP:EAUD:CHAN1:AMPL?
Response: 10.000

Related Commands :OUTPut:EAUDio:CHANnel<n>:FREQuency

:OUTPut:EAUDio:CHANnel<n>:FREQuency(?)

Use this command to set or query the frequency of a specific embedded audio channel. The unit is Hertz.

The <n> in the command represents the channel number. You can use any channel number from 1 through 8.

Syntax :OUTPut:EAUDio:CHANnel<n>:FREQuency <numeric_value>
:OUTPut:EAUDio:CHANnel<n>:FREQuency?

Parameters	Command ¹	Query response
	numeric_value = 0, 50, 100, 150, 200, 250, 300, 400, 500, 600, 750, 800, 1000, 1200, 1500, 1600, 2000, 2400, 3000, 3200, 4000, 4800, 6000, 8000, 9600, 12000, 16000	<NR2>

¹ Any nonstandard value entered will be rounded up to the next highest value

Default Value 500

Errors and Events -200 Execution error
-104 Data type error

Dependencies None

Examples
Command: :OUTP:EAUD:CHAN1:FREQ 1000
Query: :OUTP:EAUD:CHAN1:FREQ?
Response: 1000.0000

Related Commands :OUTPut:EAUDio:CHANnel<n>:AMPLitude

:OUTPut:EAUDio:GRoup<n>:PREemphasis(?)

Use this command to set or query the preemphasis of a specific embedded audio group.

The <n> in the command represents the group number. You can use group number 1 and 2.

Syntax :OUTPut:EAUDio:GRoup<n>:PREemphasis <argument>
:OUTPut:EAUDio:GRoup<n>:PREemphasis?

Parameters

Command	Query response
<argument> = OFF	OFF
CD	CD
CCITt	CCIT

Default Value OFF

Errors and Events

-200	Execution error
-141	Invalid character data
-104	Unrecognized character data

Dependencies None

Examples

Command:	:OUTP:EAUD:GR01:PRE CD
Query:	:OUTP:EAUD:GR01:PRE?
Response:	CD

Related Commands None

:OUTPut:EAUDio:GROup<n>:NBITs(?)

Use this command to set or query the sample bits of a specific embedded audio group.

The <n> in the command represents the group number. You can use group number 1 and 2.

Syntax :OUTPut:EAUDio:GROup<n>:NBITs <numeric_value>
:OUTPut:EAUDio:GROup<n>:NBITs?

Parameters	Command	Query response
	<numeric value> = 20 or 24	20 or 24

Default Value 24

Errors and Events

-200	Execution error
-141	Invalid character data
-104	Unrecognized character data

Dependencies None

Examples

Command:	:OUTPut:EAUD:GRO1:NBIT 24
Query:	:OUTPut:EAUD:GRO1:NBIT?
Response:	24

Related Commands None

:OUTPut:EAUDio:GROup<n>:SAMPLing(?)

Use this command to select or query the sampling alignment status bit of a specific embedded audio group.

The <n> in the command represents the group number. You can use group number 1 and 2.

Syntax :OUTPut:EAUDio:GROup<n>:SAMPLing <argument>
:OUTPut:EAUDio:GROup<n>:SAMPLing?

Parameters

Command	Query response
<argument> = FRAMe NOFRame ASYNc	FRAM NOFR ASYN

Default Value FRAM

Errors and Events

-200	Execution error
-141	Invalid character data
-104	Unrecognized character data

Dependencies None

Examples

Command:	:OUTP:EAUD:GRO1:SAMPLI FRAM
Query:	:OUTP:EAUD:GRO1:SAMPLI?
Response:	FRAM

Related Commands None

:OUTPut:EAUDio:NGRoups(?)

Use this command to set or query groups of embedded audio channels to the output signal. The number of groups is based on the video standard.

Syntax :OUTPut:EAUDio:NGRoups <numeric_value>
:OUTPut:EAUDio:NGRoups?

Parameters	Command	Query response
	<numeric value> = 1 or 2	<NR1>

Default Value 1

Errors and Events -200 Execution error

Dependencies None

Examples
Command: :OUTP:EAUD:NGR 2
Query: :OUTP:EAUD:NGR?
Response: 2

Related Commands :OUTPut:EAUDio:SGRoups

:OUTPut:EAUDio:SGRoups(?)

Use this command to select the starting group for embeded audio. There are no units.

Syntax :OUTPut:EAUDio:SGRoups <numeric_value>
:OUTPut:EAUDio:SGRoups?

Parameters	Command	Query response
	<NRf>	<NR1>

Default Value 1

Errors and Events -200 Execution error

Dependencies HDVG1 Generator module must be enabled.

Examples
Command: :OUTP:EAUD:SGR 2
Query: :OUTP:EAUD:SGR?
Response: 2

Related Commands :OUTPut:EAUDio:NGRoups

:OUTPut:LOGO:STATe(?)

Use this command to set or query the display of the logo overlay onto the video signal.

NOTE. *The settings of the logo overlay are independant of signal activity.*

Syntax :OUTPut:LOGO:STATe <boolean>
:OUTPut:LOGO:STATe?

Parameters

Command	Query response
<boolean> = ON or 1, OFF or 0	1, 0

Default Value OFF

Errors and Events -200 Execution error
-141 Invalid character data

Dependencies None

Examples Command: :OUTP:LOGO:STAT 1
Query: :OUTP:LOGO:STAT?
Response: 1

Related Commands :OUTPut:LOGO:POSition:VERTical,
:OUTPut:LOGO:POSition:HORizontal

:OUTPut:LOGO:POSition:HORizontal(?)

Use this command to set or query the horizontal position of the logo as it appears on the active signal. The unit is percent of average picture width.

Syntax :OUTPut:LOGO:POSition:HORizontal <numeric_value>
:OUTPut:LOGO:POSition:HORizontal?

Parameters	Command	Query response
	<numeric_value> = <NRf> -100.0 ≤ <NRf> ≤ 0.0 MIN, MAX, DEF	<NR2>

Default Value 0

Errors and Events -200 Execution error
-120 Numeric data error

Dependencies None

Examples
Command: :OUTP:LOGO:POS:HOR -35
Query: :OUTP:LOGO:POS:HOR?
Response: -35.0000

Related Commands :OUTPut:LOGO:POSition:VERTical

:OUTPut:LOGO:POSition:VERTical(?)

Use this command to set or query the vertical position of the logo as it appears on the active signal. The unit is percent of average picture height.

Syntax :OUTPut:LOGO:POSition:VERTical <numeric_value>
:OUTPut:LOGO:POSition:VERTical?

Parameters	Command	Query response
	<numeric_value> = <NRf> -100.0 ≤ <NRf> ≤ 0.0	<NR2>
	MIN, MAX, DEF	

Default Value 0

Errors and Events -200 Execution error
-120 Numeric data error

Dependencies None

Examples Command: :OUTP:LOGO:POS:VERT -35
Query: :OUTP:LOGO:POS:VERT?
Response: -35.0000

Related Commands :OUTPut:LOGO:POSition:HORizontal

:OUTPut:LOGO:RESet

Use this command to reset the parameters of the logo overlay. There are no arguments.

Syntax :OUTPut:LOGO:RESet

Parameters

Command	Query response
None	None

Default Value Not applicable

Errors and Events -200 Execution error

Dependencies HDVG1 Generator module must be enabled.

Examples Command: :OUTP:LOGO:RES

Related Commands None

:OUTPut:LOGO:SElect(?)

Use this command to select or query the current logo used for the logo overlay.

Syntax :OUTPut:LOGO:SElect <file_name>
:OUTPut:LOGO:SElect?

Parameters	Command	Query response
	<file_name> = <string>	<string>

Default Value Not applicable

Errors and Events -200 Execution error

Dependencies HDVG1 Generator module must be enabled.

Examples
Command: :OUTP:LOGO:SEL "sample.lgo"
Query: :OUTP:LOGO:SEL?
Response: "sample.lgo"

Related Commands :OUTPut:LOGO:POSition:HORizontal
:OUTPut:LOGO:POSition:VERTical

:OUTPut:TEXT:STATe(?)

Use this command to set or query the text overlay onto the video signal.

Syntax :OUTPut:TEXT:STATe <boolean>
:OUTPut:TEXT:STATe?

Parameters

Command	Query response
<boolean> = ON or 1, OFF or 0	1, 0

Default Value Not applicable

Errors and Events -200 Execution error

Dependencies None

Examples
Command: :OUTP:TEXT:STAT 1
Query: :OUTP:TEXT:STAT?
Response: 1

Related Commands
:OUTPut:TEXT:POSition:VERTical
:OUTPut:TEXT:POSition:HORizontal
:OUTPut:TEXT:DATA

:OUTPut:TEXT:DATA(?)

Use this command to set or query the current string for the text mode. Text information is part of the active signal. To save text with a signal, the signal must be saved.

Syntax :OUTPut:TEXT:DATA <string>
:OUTPut:TEXT:DATA?

Parameters	Command	Query response
	<string>	<string>

Default Value Not applicable

Errors and Events -200 Execution error

Dependencies None

Examples
Command: :OUTPut:TEXT:DATA "This is a test."
Query: :OUTPut:TEXT:DATA?
Response: "This is a test."

Related Commands :OUTPut:TEXT:POSition:VERTical
:OUTPut:TEXT:POSition:HORizontal

:OUTPut:TEXT:POSition:HORizontal(?)

Use this command to set or query the horizontal position of text in the video signal. The unit is percentage of average picture width.

Syntax :OUTPut:TEXT:POSition:HORizontal <numeric_value>
:OUTPut:TEXT:POSition:HORizontal?

Parameters	Command	Query response
	<numeric_value> = <NRf> MIN, MAX, DEF	<NR2>

Default Value 10

Errors and Events -200 Execution error

Dependencies None

Examples
Command: :OUTP:TEXT:POS:HOR 35
Query: :OUTP:TEXT:POS:HOR?
Response: 35.0000

Related Commands :OUTPut:TEXT:POSition:VERTical

:OUTPut:TEXT:POSition:VERTical(?)

Use this command to set or query the vertical position of text in the video signal. The unit is percentage of average picture height.

Syntax :OUTPut:TEXT:POSition:VERTical <numeric_value>
:OUTPut:TEXT:POSition:VERTical?

Parameters	Command	Query response
	<numeric_value> = <NRf> MIN, MAX, DEF	<NR2>

Default Value 10

Errors and Events -200 Execution error

Dependencies None

Examples
Command: :OUTP:TEXT:POS:VERT 35
Query: :OUTP:TEXT:POS:VERT?
Response: 35.0000

Related Commands :OUTPut:TEXT:POSition:HORizontal

:OUTPut:TEXT:RESet

Use this command to reset the parameters of the text overlay. There are no arguments.

Syntax :OUTPut:TEXT:RESet

Parameters

Command	Query response
None	None

Default Value Not applicable

Errors and Events -200 Execution error

Dependencies HDVG1 Generator module must be enabled.

Examples Command: :OUTP:TEXT:RES

Related Commands :OUTPut:TEXT

:OUTPut:TRIGger:CURSor:STATe(?)

Use this command to set or query the cursor display. The trigger output signal is not affected by this command.

Syntax :OUTPut:TRIGger:CURSor:STATe <boolean>
:OUTPut:TRIGger:CURSor:STATe?

Parameters	Command	Query response
	<boolean> = ON or 1, OFF or 0	1, 0

Default Value OFF

Errors and Events -200 Execution error

Dependencies None

Examples
Command: :OUTP:TRIG:CURS:STAT 1
Query: :OUTP:TRIG:CURS:STAT?
Response: 1

Related Commands None

:OUTPut:TRIGger:POSition:HORizontal(?)

Use this command to set or query the trigger position horizontally within the video signal. The unit is microseconds.

NOTE. *There is interaction between the vertical and horizontal parameters since these parameters combine to resolve any overlap.*

Syntax :OUTPut:TRIGger:POSition:HORizontal <numeric_value>
:OUTPut:TRIGger:POSition:HORizontal?

Parameters

Command	Query response
<numeric_value> = <NRf>	<NR2>
UP, DOWN, DEF	

Default Value 0.0

Errors and Events -200 Execution error

Dependencies None

Examples Command: :OUTP:TRIG:POS:HOR 32.5

Query: :OUTP:TRIG:POS:HOR?

Response: 32.5000

Related Commands :OUTPut:TRIGger:POSition:VERTical
:OUTPut:TRIGger:POSition:HORizontal:STEP

:OUTPut:TRIGger:POSition:HORizontal:STEP(?)

Use this command to set or query the UP/DOWN step value for the associated command. The unit is microseconds.

Syntax :OUTPut:TRIGger:POSition:HORizontal:STEP <numeric_value>
 :OUTPut:TRIGger:POSition:HORizontal:STEP?

Parameters	Command	Query response
	<numeric_value> = <NRf> MIN, MAX, DEF	<NR2>

Default Value 1

Errors and Events -200 Execution error

Dependencies None

Examples

Command: :OUTP:TRIG:POS:HOR:STEP 0.5

Query: :OUTP:TRIG:POS:HOR:STEP?

Response: 0.5000

Related Commands :OUTPut:TRIGger:POSition:HORizontal

:OUTPut:TRIGger:POSition:HORizontal:SAMPle(?)

Use this command to set or query the horizontal parameter of the trigger and its overlay. The unit is sample.

Syntax :OUTPut:TRIGger:POSition:HORizontal:SAMPle <numeric_value>
:OUTPut:TRIGger:POSition:HORizontal:SAMPle?

Parameters	Command	Query response
	<numeric_value> = <NRf> UP, DOWN, DEF	<NR2>

Default Value Not applicable

Errors and Events -200 Execution error

Dependencies HDVG1 Generator module must be enabled.

Examples
 Command: :OUTP:TRIG:POS:HOR:SAMP 120
 Query: :OUTP:TRIG:POS:HOR:SAMP?
 Response: 120

Related Commands :OUTPut:TRIGger:POSition:HORizontal

:OUTPut:TRIGger:POSition:HORizontal:SAMPle:STEP(?)

Use this command to set or query the UP/DOWN step value for the associated command. The unit is sample.

Syntax :OUTPut:TRIGger:POSition:HORizontal:SAMPle:STEP <numeric_value>
:OUTPut:TRIGger:POSition:HORizontal:SAMPle:STEP?

Parameters	Command	Query response
	<numeric_value> = <NRf>	<NR2>
	MIN, MAX, DEF	

Default Value Not applicable

Errors and Events -200 Execution error

Dependencies HDVG1 Generator module must be enabled.

Examples
Command: :OUTP:TRIG:POS:HOR:SAMP:STEP 12
Query: :OUTP:TRIG:POS:HOR:SAMP:STEP?
Response: 12

Related Commands :OUTPut:TRIGger:POSition:HORizontal:SAMPle

:OUTPut:TRIGger:POSition:VERTical(?)

Use this command to set or query the trigger position vertically within the video signal. The unit is number of lines.

NOTE. *There is interaction between the vertical and horizontal parameters since these parameters combine to resolve any overlap.*

Syntax :OUTPut:TRIGger:POSition:VERTical <numeric_value>
:OUTPut:TRIGger:POSition:VERTical?

Parameters

Command	Query response
<numeric_value> = <NRf>	<NR2>
UP, DOWN, DEF	

Default Value 1.0

Errors and Events -200 Execution error

Dependencies None

Examples
 Command: :OUTP:TRIG:POS:VERT 45
 Query: :OUTP:TRIG:POS:VERT?
 Response: 45.0000

Related Commands :OUTPut:TRIGger:POSition:HORizontal
:OUTPut:TRIGger:POSition:VERTical:STEP

:OUTPut:TRIGger:POSition:VERTical:STEP(?)

Use this command to set or query the UP/DOWN step value for the associated command. The unit is number of lines.

Syntax :OUTPut:TRIGger:POSition:VERTical:STEP <numeric_value>
:OUTPut:TRIGger:POSition:VERTical:STEP?

Parameters	Command	Query response
	<numeric_value> = <NRf> MIN, MAX, DEF	<NR2>

Default Value 1.0

Errors and Events -200 Execution error

Dependencies None

Examples
Command: :OUTP:TRIG:POS:VERT:STEP 5
Query: :OUTP:TRIG:POS:VERT:STEP?
Response: 5.0000

Related Commands :OUTPut:TRIGger:POSition:VERTical

:OUTPut:TRIGger:TYPE(?)

Use this command to select or query the trigger and cursor display types. The selections affect the type of cursor displayed and the occurrence of the trigger output.

There are four trigger types:

- PIXel: a trigger occurs where the horizontal and vertical lines cross
- VERTical: a trigger occurs at the horizontal line (1 pulse per frame)
- HORizontal: a trigger occurs at the vertical line (1 pulse per line)
- OFF: no trigger output

Syntax :OUTPut:TRIGger:TYPE <type>
:OUTPut:TRIGger:TYPE?

Parameters

Command	Query response
<type> = PIXel VERTical HORizontal OFF	PIX VERT HOR OFF

DEfault Value PIX

Errors and Events

-200	Execution error
-141	Invalid character data

Dependencies None

Examples

Command: :OUTP:TRIG:TYPE PIXEL

Query: :OUTP:TRIG:TYPE?

Response: PIX

Related Commands None

:OUTPut:TRIGger:RESet

Use this command to reset the parameters of the trigger and its overlay. There are no arguments.

Syntax :OUTPut:TRIGger:RESet

Parameters	Command	Query response
	None	None

Default Value Not applicable

Errors and Events -200 Execution error

Dependencies HDVG1 Generator module must be enabled.

Examples Command: :OUTP:TRIG:RES

Related Commands :OUTPut:TRIGger

:SENSe Subsystem

Use these commands to adjust the timing of the module in relation to the instrument. The adjustments set the module delay.

Command Tree

```
:SENSe
  :CORRection
  :MDElay
    :VERTical      <numeric_value>
      :STEP        <numeric_value>
    :HORizontal    <numeric_value>
      :STEP        <numeric_value>
```

:SENSe:CORRection:MDELay:HORizontal(?)

Use this command to set or query the horizontal timing delay of the module with respect to the rest of the instrument.

The units is microseconds. If the argument exceeds the horizontal time value, then the vertical delay is adjusted to accommodate the requested delay.

Settings are saved through power cycles.

Syntax :SENSe:CORRection:MDELay:HORizontal <numeric_value>
:SENSe:CORRection:MDELay:HORizontal?

Parameters	Command	Query response
	<numeric_value> = <NRf> UP, DOWN DEF	<NR2>

Default Value 0.0

Errors and Events -200 Execution error

Dependencies None

Examples
Command: :SENS:CORR:MDEL:HOR 23.0
Query: :SENS:CORR:MDEL:HOR?
Response: 23.0000

Related Commands :SENSe:CORRection:MDELay:VERTical
:SENSe:CORRection:MDELay:HORizontal:STEP

:SENSe:CORRection:MDELay:HORizontal:STEP(?)

Use this command to set or query the step increment used by the UP or DOWN commands. The unit is microseconds.

Syntax :SENSe:CORRection:MDELay:HORizontal:STEP <numeric_value>
:SENSe:CORRection:MDELay:HORizontal:STEP?

Parameters	Command	Query response
	<numeric_value> = <NRf> MIN, MAX, DEF	<NR2>

Default Value 1.0000

Errors and Events -200 Execution error

Dependencies None

Examples
 Command: :SENS:CORR:MDEL:HOR:STEP 5
 Query: :SENS:CORR:MDEL:HOR:STEP?
 Response: 5.0000

Related Commands :SENSe:CORRection:MDELay:HORizontal

:SENSe:CORRection:MDELay:VERTical(?)

Use this command to set or query the vertical time delay of the module. The argument can be an floating point value that is translated into integer lines with a horizontal offset.

The query returns an integer value even if the command used a floating point argument. (The fractional parts are used to adjust the HORizontal offset.)

Settings are saved through power cycles.

Syntax :SENSe:CORRection:MDELay:VERTical <numeric_value>
:SENSe:CORRection:MDELay:VERTical?

Parameters

Command	Query response
<numeric_value> = <NRf> UP, DOWN DEF	<NR2>

Default Value 0

Errors and Events -200 Execution error

Dependencies None

Examples
Command: :SENS:CORR:MDEL:VERT 12
Query: :SENS:CORR:MDEL:VERT?
Response: 12.0000

Related Commands :SENSe:CORRection:MDELay:HORizontal
:SENSe:CORRection:MDELay:VERTical:STEP

:SENSe:CORRection:MDElay:VERTical:STEP(?)

Use this command to set or query the UP/DOWN step value of the associated command.

Syntax :SENSe:CORRection:MDElay:VERTical:STEP? <numeric_value>

Parameters	Command	Query response
	<numeric_value> = <NRf>	<NR2>
	MIN, MAX, DEF	

Default Value 1.0

Errors and Events -200 Execution error

Dependencies None

Examples

Command: :SENS:CORR:MDEL:VERT:STEP 2

Query: :SENS:CORR:MDEL:VERT:STEP?

Response: 2.0000

Related Commands :SENSe:CORRection:MDElay:VERTical

:SOURce Commands

Use the SOURce commands to control the signal source for the module. These commands display the signal name and enable the adjustment of many parameters.

Command Tree

```
:SOURce
  :MVIDeo
    :AVIDeo          <numeric_value>
      :STEP          <numeric_value>
    :CHROMa
      :AMPLitude    <numeric_value>
        :STEP        <numeric_value>
    :LUMinance       <numeric_value>
      :STEP          <numeric_value>
    :PB              <numeric_value>
      :STEP          <numeric_value>
    :PR              <numeric_value>
      :STEP          <numeric_value>
    :TIMEbase        <numeric_value>
      :STEP          <numeric_value>
```

:SOURce:MVIDeo:AVIDeo(?)

Use this command to set or query the amplitude of the active video portion of the video signal.

Syntax :SOURce:MVIDeo:AVIDeo <numeric_value>
:SOURce:MVIDeo:AVIDeo?

Parameters	Command	Query response
	<numeric_value> = <NRf> MIN, MAX, UP, DOWN DEF	<NR2>

Default Value 100 PCT

Errors and Events -200 Execution error

Dependencies There is interaction with other parameters that address amplitudes

Examples
Command: :SOUR:MVID:AVID 20
Query: :SOUR:MVID:AVID?
Response: 20.0000

Related Commands None

:SOURce:MVIDeo:AVIDeo:STEP(?)

Use this command to set or query the UP/DOWN step value of the active video portion of the video signal.

Syntax :SOURce:MVIDeo:AVIDeo:STEP <numeric_value>
:SOURce:MVIDeo:AVIDeo:STEP?

Parameters	Command	Query response
	<numeric_value> = <NRf> MIN, MAX, DEF	<NR2>

Default Value 1.0 PCT

Errors and Events -200 Execution error

Dependencies None

Examples
Command: :SOUR:MVID:AVID:STEP 5
Query: :SOUR:MVID:AVID:STEP?
Response: 5.0000

Related Commands None

:SOURce:MVIDeo:PB(?)

Use this command to set or query the amplitude of the PB component of an HW-modulated component video signal.

Syntax :SOURce:MVIDeo:PB <numeric_value>
:SOURce:MVIDeo:PB?

Parameters	Command	Query response
	<numeric_value> = <NRf> MIN, MAX, UP, DOWN DEF	<NR2>

Default Value 100 PCT

Errors and Events -200 Execution error

Dependencies Amplitude affected by :SOUR:MVID:AVID and :SOUR:MVID:CHR:AMPL

Examples
Command: :SOUR:MVID:PB 2
Query: :SOUR:MVID:PB?
Response: 2.0000

Related Commands :SOURce:MVIDeo:PR,
:SOURce:MVIDeo:CHRoma:AMPLitude

:SOURce:MVIDeo:PB:STEP(?)

Use this command to set or query the UP/DOWN step value of the PB component of an HW-modulated component video signal.

Syntax :SOURce:MVIDeo:PB:STEP <numeric_value>
:SOURce:MVIDeo:PB:STEP?

Parameters	Command	Query response
	<numeric_value> = <NRf> MIN, MAX, DEF	<NR2>

Default Value 1.0 PCT

Errors and Events -200 Execution error

Dependencies None

Examples
Command: :SOUR:MVID:PB:STEP 5
Query: :SOUR:MVID:PB:STEP?
Response: 5.0000

Related Commands None

:SOURce:MVIDeo:CHRoma:AMPLitude(?)

Use this command to set or query the amplitude of the chroma portion of an HW-modulated component video signal.

Syntax :SOURce:MVIDeo:CHRoma:AMPLitude <numeric_value>
:SOURce:MVIDeo:CHRoma:AMPLitude?

Parameters	Command	Query response
	<numeric_value> = <NRf> MIN, MAX, UP, DOWN DEF	<NR2>

Default Value 100 PCT

Errors and Events -200 Execution error

Dependencies Amplitude affected by :SOUR:MVID:AVID (This affects :RY and :BY)

Examples
Command: :SOUR:MVID:CHR:AMPL 90
Query: :SOUR:MVID:CHR:AMPL?
Response: 90.0000

Related Commands None

:SOURce:MVIDeo:CHRoma:AMPLitude:STEP(?)

Use this command to set or query the UP/DOWN step value of the chroma portion of an HW-modulated component video signal.

Syntax :SOURce:MVIDeo:CHRoma:AMPLitude:STEP <numeric_value>
:SOURce:MVIDeo:CHRoma:AMPLitude:STEP?

Parameters	Command	Query response
	<numeric_value> = <NRf> MIN, MAX, DEF	<NR2>

Default Value 1.0 PCT

Errors and Events -200 Execution error

Dependencies None

Examples
Command: :SOUR:MVID:CHR:AMPL:STEP 5
Query: :SOUR:MVID:CHR:AMPL:STEP?
Response: 5.0000

Related Commands None

:SOURce:MVIDeo:LUMinance(?)

Use this command to set or query the amplitude of the luminance portion of an HW-modulated component video signal.

Syntax :SOURce:MVIDeo:LUMinance <numeric_value>
:SOURce:MVIDeo:LUMinance?

Parameters	Command	Query response
	<numeric_value> = <NRf> MIN, MAX, UP, DOWN DEF	<NR2>

Default Value 100 PCT

Errors and Events -200 Execution error

Dependencies Amplitude affected by :SOUR:MVID:AVID

Examples
Command: :SOUR:MVID:LUM 95
Query: :SOUR:MVID:LUM?
Response: 95.0000

Related Commands None

:SOURce:MVIDeo:LUMinance:STEP(?)

Use this command to set or query the UP/DOWN step value of the luminance portion of an HW-modulated component video signal.

Syntax :SOURce:MVIDeo:LUMinance:STEP <numeric_value>
:SOURce:MVIDeo:LUMinance:STEP?

Parameters	Command	Query response
	<numeric_value> = <NRf> MIN, MAX, DEF	<NR2>

Default Value 1.0 PCT

Errors and Events -200 Execution error

Dependencies None

Examples
Command: :SOUR:MVID:LUM:STEP 5
Query: :SOUR:MVID:LUM:STEP?
Response: 5.0000

Related Commands None

:SOURce:MVIDeo:PR(?)

Use this command to set or query the amplitude of the PR component of an HW-modulated component video signal.

Syntax :SOURce:MVIDeo:PR <numeric_value>
:SOURce:MVIDeo:PR?

Parameters	Command	Query response
	<numeric_value> = <NRf> MIN, MAX, UP, DOWN DEF	<NR2>

Default Value 100 PCT

Errors and Events -200 Execution error

Dependencies Amplitude affected by :SOUR:MVID:AVID and :SOUR:MVID:CHR:AMPL

Examples
Command: :SOUR:MVID:PR 80
Query: :SOUR:MVID:PR?
Response: 80.0000

Related Commands :SOURce:MVIDeo:PB,
:SOURce:MVIDeo:CHRoma:AMPLitude

:SOURce:MVIDeo:PR:STEP(?)

Use this command to set or query the UP/DOWN step value of the PR component of an HW-modulated component video signal.

Syntax :SOURce:MVIDeo:PR:STEP <numeric_value>
:SOURce:MVIDeo:PR:STEP?

Parameters	Command	Query response
	<numeric_value> = <NRf> MIN, MAX, DEF	<NR2>

Default Value 1.0 PCT

Errors and Events -200 Execution error

Dependencies None

Examples
Command: :SOUR:MVID:PR:STEP 2
Query: :SOUR:MVID:PR:STEP?
Response: 2.0000

Related Commands None

:SOURce:MVIDeo:TIMEbase(?)

Use this command to set or query the underlying timebase of the module. The units are PPM.

If the first argument is zero, an optional argument of FRAME or NOFRame will enable or disable the frame reset for the signal. The default is NOFRame.

If the first argument is a nonzero value, it will override an optional argument of FRAME, defaulting to NOFRame.

Syntax :SOURce:MVIDeo:TIMEbase <numeric_value>
:SOURce:MVIDeo:TIMEbase?

Parameters

Command	Query response
<numeric_value> = <NRf> MIN, MAX, UP, DOWN, DEF	<NR2>, NOFR
<frame> = .NOFRame FRAME	<NR2>, FRAM

Default Value 0

Errors and Events -200 Execution error

Dependencies HDVG1 module must be enabled.

Examples
Command: :SOUR:MVID:TIME 20
Query: :SOUR:MVID:TIME?
Response: 20,NOFR

Related Commands :SOURce:MVIDeo

:SOURce:MVIDeo:TIMEbase:STEP(?)

Use this command to change the UP/DOWN step value for the associated command. The units are PPM.

Syntax :SOURce:MVIDeo:TIMEbase <numeric_value>
:SOURce:MVIDeo:TIMEbase?

Parameters	Command	Query response
	<numeric_value> = <NRf> MIN, MAX, DEF	<NR2>

Default Value 1

Errors and Events -200 Execution error

Dependencies HDVG1 module must be enabled.

Examples
Command: :SOUR:MVID:TIME:STEP 2
Query: :SOUR:MVID:TIME:STEP?
Response: 2.0

Related Commands :SOURce:MVIDeo:TIMEbase

Appendix A: Specifications

Table A-1 lists the Electrical specifications for the HDVG1 Generator module. Refer to the *TG 2000 Signal Generation Platform User Manual* for a list of Environmental specifications. Table A-2 list the certification and compliances.

Table A-1: Electrical specifications

Characteristics	Description
Serial Connector	
Number of Outputs	3 (BNC)
Signal Amplitude	800 mV typical, into 75 Ω load
Data Rate	1.485 Gbps or 1.485/1.001 Gbps nominal
Overshoot	$\leq 10\%$
Rise and Fall Times	≤ 270 ps (Measured at 20% and 80% points; difference less than 100 ps)
DC Offset (Ac coupled)	0.0 V \pm 0.5 V (Into DC termination)
Jitter	≤ 135 ps p-p (Alignment jitter)
Return Loss (75 Ω , AC coupled)	≥ 15 dB, 5 MHz to 742.5 MHz ≥ 10 dB, 742.5 MHz to 1.485 GHz
Trigger Output	
Connector	BNC
Amplitude	TTL compatible if unterminated
Rise Time	≤ 10 ns
Output Impedance	75 Ω
Typical Power Consumption	+5 Volts: 14.0 Watts -5 Volts: 1.0 Watts -2 Volts: 1.0 Watts Battery: 30 μ A maximum

Table A-2: Certifications and compliances

Category	Standards or description
EC Declaration of Conformity – EMC	<p>Meets intent of Directive 89/336/EEC for Electromagnetic Compatibility. Compliance was demonstrated to the following specifications as listed in the Official Journal of the European Union:</p> <p>EN 55022 Class B Radiated and Conducted Emissions</p> <p>EN 55103-1 Emissions: Annex A Magnetic Loop Antenna</p> <p>EN 55103-2 Immunity: EN 61000-4-2 Electrostatic Discharge Immunity EN 61000-4-3 Radiated RF Electromagnetic Field Amplitude Modulated EN 61000-4-4 Electrical Fast Transient Immunity EN 61000-4-5 Surge Immunity EN 61000-4-6 Conducted RF Common Mode Immunity EN 61000-4-11 Power Line Interruption Immunity Annex A Magnetic Immunity</p>
Australia/New Zealand Declaration of Conformity – EMC	<p>Complies with EMC provision of Radiocommunications Act per the following standard(s):</p> <p>AS/NZS 2064.1/2 Industrial, Scientific, and Medical Equipment: 1992</p>
FCC Compliance	Emissions comply with FCC Code of Federal Regulations 47, Part 15, Subpart B, Class A Limits.
EC Declaration of Conformity – Low Voltage	<p>Compliance was demonstrated to the following specification as listed in the Official Journal of the European Union:</p> <p>Low Voltage Directive 73/23/EEC, amended by 93/68/EEC</p> <p>EN 61010-1:1993 Safety requirements for electrical equipment for measurement control and laboratory use.</p>
Safety	<p>Complies with the following safety standards:</p> <p>UL3111-1¹ Standard for electrical measuring and test equipment.</p> <p>CAN/CSA C22.2 No. 1010.1¹ Safety requirements for electrical equipment for measurement, control, and laboratory use.</p> <p>IEC61010-1¹ Safety requirements for electrical equipment for measurement, control, and laboratory use.</p>

1 UL3111-1, CSA C22.2 No. 1010.1, and IEC61010-1 Safety Certification Compliance Altitude (maximum operating) : 2000 meters

Appendix B: SCPI Conformance Information

All commands in the HDVG1 Generator module are based on SCPI Version 1994.0. Table B-1 lists all commands supported by the generator. The columns at right show whether a command is defined in the SCPI 1994.0 Standard or not.

Table B-1: SCPI Conformance Information

Command			Defined in SCPI 1994.0	Not Defined In SCPI 1994.0
OUTPut	CIRClE	DIAMeter(?)		✓
		POSition	HORizontal(?)	✓
			VERTical(?)	✓
		RESet		✓
		STATe(?)		✓
EAUDio	CHANnel<n>	AMPLitude(?)		✓
			FREQuency(?)	✓
			STATe(?)	✓
	GRoup<n>	NBITs(?)		✓
			PREEmphasis(?)	✓
			SAMPLIng(?)	✓
			NGROups(?)	✓
		SGROups(?)		✓
		STATe(?)		✓
	LOGO	POSition	HORizontal(?)	
			VERTical(?)	✓
		RESet		✓
		SElect(?)		✓
		STATe(?)		✓
		STATe(?)	✓	
TEXT		DATA(?)		✓
	POSition	HORizontal(?)		✓
			VERTical(?)	
		RESet		✓
			STATe(?)	

Table B-1: SCPI Conformance Information (Cont.)

Command				Defined in SCPI 1994.0	Not Defined In SCPI 1994.0
OUTPut	TRIGger	TYPE(?)			✓
		CURSor	STATe(?)		✓
		POSition	HORizontal(?)		✓
			STEP(?)		✓
			SAMPle(?)		✓
			STEP(?)		✓
			VERTical(?)		✓
			STEP(?)		✓
		RESet			✓
SENSe	CORRection	MDELay	HORizontal(?)		✓
			STEP(?)		✓
			VERTical(?)		✓
			STEP(?)		✓
SOURce	MVIDeo	AVIDeo(?)			✓
			STEP(?)		✓
		PB(?)			✓
			STEP(?)		✓
		CHRoma	AMPLitude(?)		✓
			STEP(?)		✓
		LUMinance(?)			✓
			STEP(?)		✓
		PR(?)			✓
			STEP(?)		✓
		TIMEbase(?)			✓
			STEP(?)		✓

WARNING

The following servicing instructions are for use only by qualified personnel. To avoid injury, do not perform any servicing other than that stated in the operating instructions unless you are qualified to do so. Refer to the General Safety Summary and Service Safety Summary before performing any service.

Service Safety Summary

Only qualified personnel should perform service procedures. Read this *Service Safety Summary* and the *General Safety Summary* before performing any service procedures.

Do Not Service Alone. Do not perform internal service or adjustments of this product unless another person capable of rendering first aid and resuscitation is present.

Disconnect Power. To avoid electric shock, disconnect the main power by means of the power cord or, if provided, the power switch.

Use Care When Servicing With Power On. Dangerous voltages or currents may exist in this product. Disconnect power, remove battery (if applicable), and disconnect test leads before removing protective panels, soldering, or replacing components.

To avoid electric shock, do not touch exposed connections.

Appendix C: Installation

This section covers module installation, signal backup, and module removal.

Preventing Component Damage



CAUTION. *Electrostatic discharge (ESD) can damage components on this module and mainframe. To prevent ESD or other component damage, follow the steps below when installing, removing, or handling modules:*

1. Wear a grounded antistatic wrist strap to discharge the static voltage from your body while installing or removing modules from the TG 2000 Platform mainframe.
2. Transport and store modules in a static-protected bag or container.
3. Do not slide the module over any surface.
4. Handle modules as little as possible.
5. Do not touch module components or connector pins.
6. Do not use any devices capable of generating or holding a static charge in the work area where you remove, install, or handle modules.
7. Avoid handling modules in areas that have a floor or work-surface covering capable of generating a static charge.
8. Do not remove the module circuit board assembly from the shield. The shield is an important stiffener which prevents damage to surface-mount components.

Module Installation

A T-10 torx tip screwdriver is the only tool you need to install the module. A T-10 torx tip is supplied with the module.

Hardware Installation

To install the module into the TG 2000 Platform mainframe, perform these steps:

1. Set the TG 2000 Platform mainframe rear-panel power switch to off. Unplug the power cord.
2. Select the slot you will use to install the module. Table C-1 lists the slot restrictions. Figure C-1 shows a sample configuration with slot numbers.

Table C-1: Module slot assignments

Module	Slots in which the module can be installed
AGL1 Genlock module	Slot 2 or 3
AVG1 Generator module	Slots 2 through 10
AWVG1 Generator module	Slots 2 through 10
BG1 Generator module	Slots 2 through 10
Clock module	Slot 1
CPU module	Slot 11
DVG1 Generator module	Slots 2 through 10
GP1 GPIB Interface module	Slot 10
HDVG1 Generator module	Slots 2 through 10

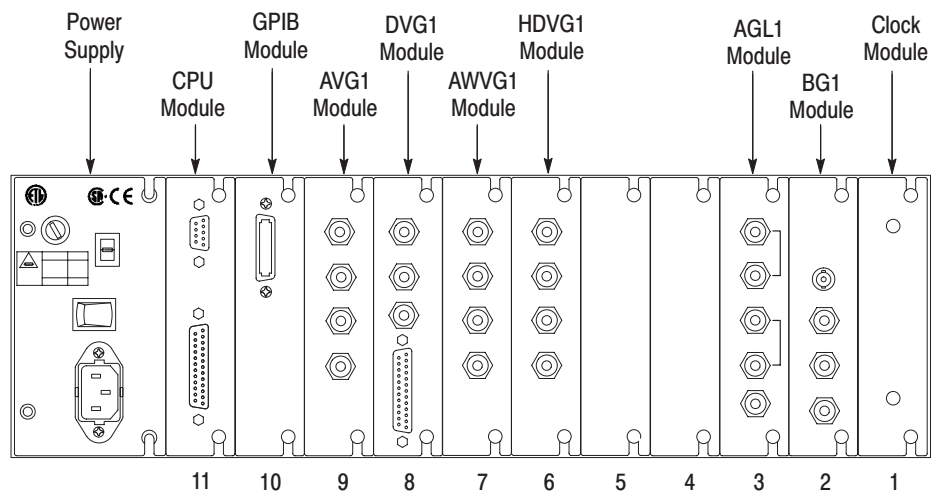

Figure C-1: Rear panel slot numbering



WARNING. To avoid a shock hazard, always remove the power cord before removing the top cover. Failure to remove the power cord can result in serious injury or death.

3. Refer to Figure C-2 and remove or loosen all screws to remove the top cover.

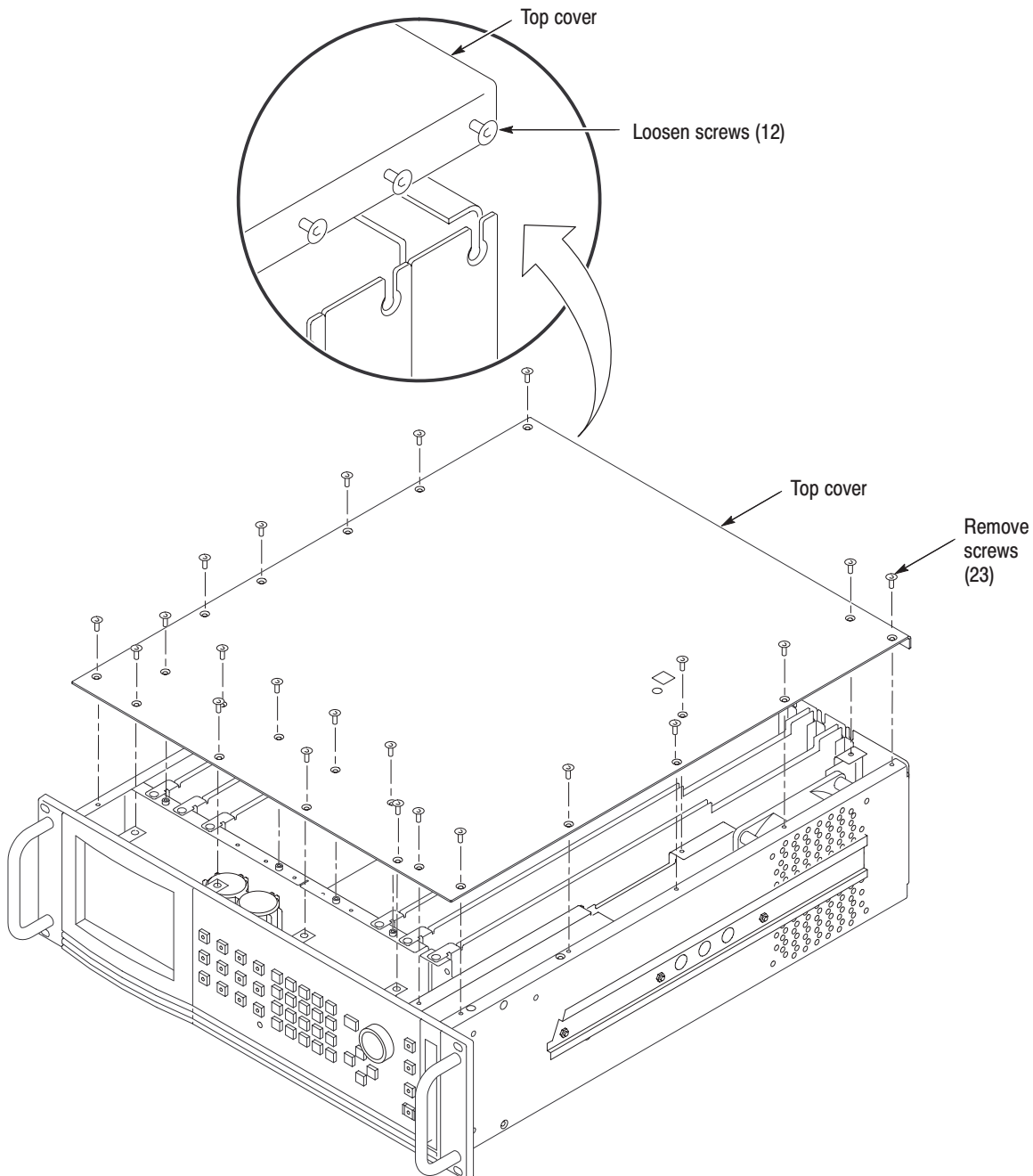

Figure C-2: Top cover removal

4. Remove the appropriate rear panel as shown in Figure C-3. Loosen, but do not remove the bottom screw. You will use it later to secure the module.

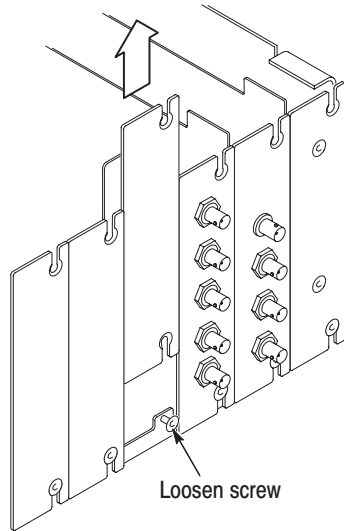

Figure C-3: Removing the rear panel

5. While ensuring correct alignment of the module flange as shown in Figure C-4, lower the module into the desired slot as shown in Figure C-5.

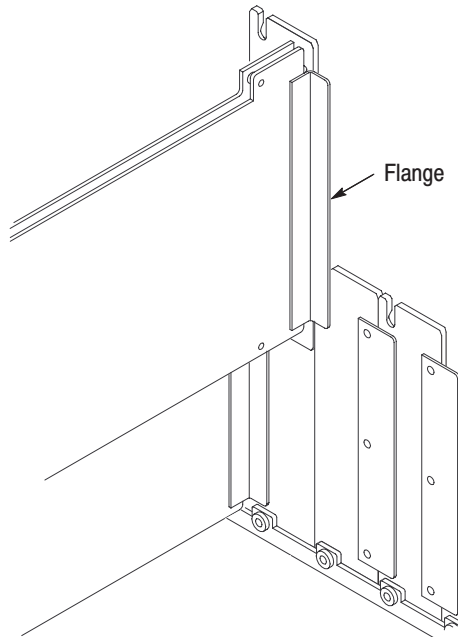

Figure C-4: Module flange

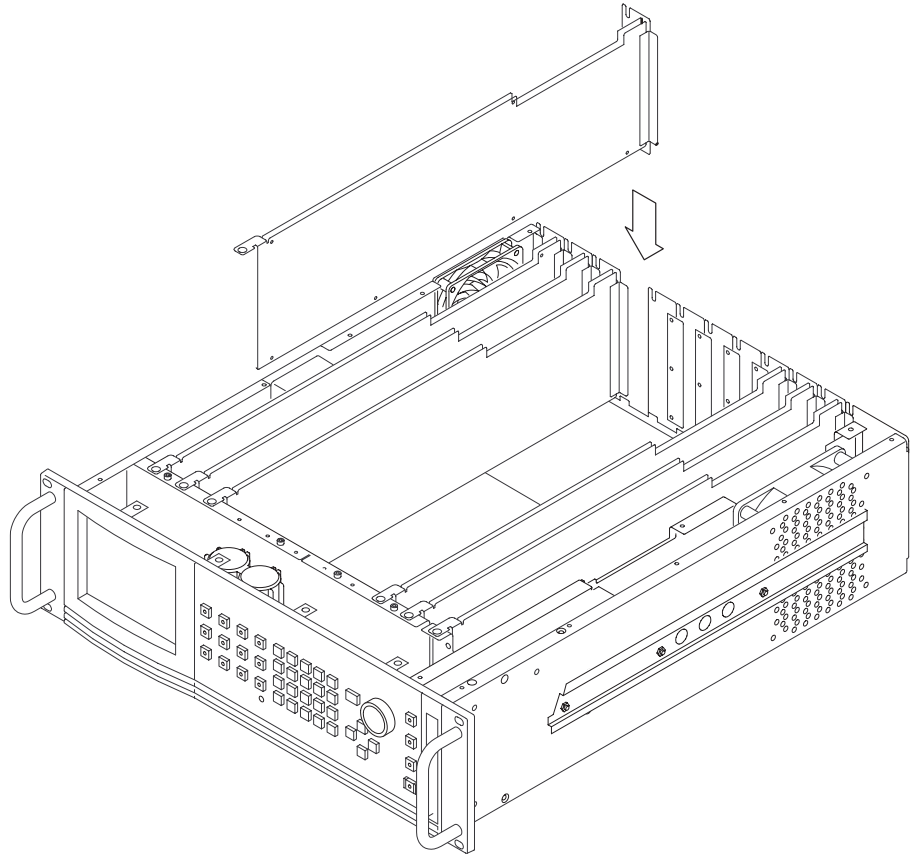

Figure C-5: Installing the module

6. Ensure that the connectors on the Backplane board and the module exactly match before seating the module.



CAUTION. *The connectors must exactly match before you attempt to press the module firmly in place. If the connectors do not match you could bend a pin that could damage the module, mainframe, or both when power is applied.*

7. Press down evenly on the module until it is firmly in place.
8. Insert and tighten the top screw, which is supplied with your module, as shown in Figure C-6.
9. Tighten the rear-panel screw.

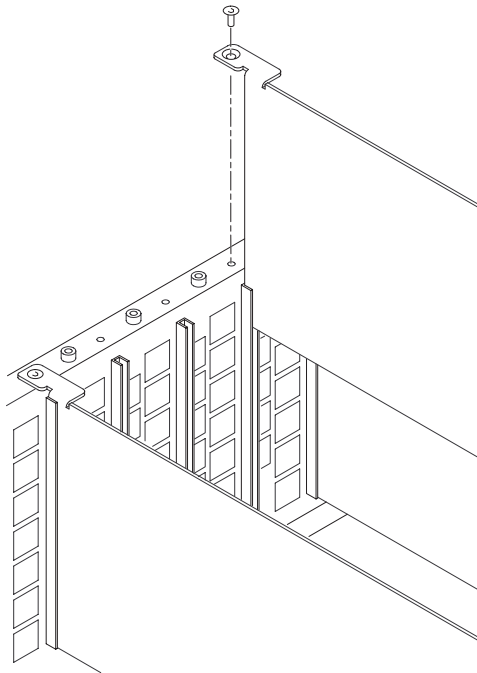

Figure C-6: Top screw

10. Replace the top cover.
11. Insert and tighten all top cover screws.
12. Plug in the instrument power cord.
13. Power on the mainframe by setting the rear-panel power switch to ON and pressing the front-panel power switch.
14. Wait for the instrument to perform self tests.

Signal Set Installation

If this module was installed in the TG 2000 Platform mainframe at the factory, signal sets are already installed. If a generator module is ordered separately, you must install signal sets when installing the module. If you need to install signal sets, use one of the two following procedures. To replace signal sets, refer to the *TG 2000 Signal Generation Platform User Manual*.

Installing Signals to the Default Destination.

1. Insert the test signal disk into the TG 2000 Platform mainframe disk drive.
2. Push the **DISK** button.
3. Touch **Add Signals** when the Disk menu appears.

4. Touch **Select Source**.
5. Use the **NAVIGATION** arrows to move the cursor to the .DNL (Download Library) you want to load and push the **Select** button.
6. Select all of the signal sets at the module level, in the signals field, and push the **Select** button.
7. Touch **Quit/Load**. The previous menu appears.
8. Touch **Quit/Load** again. The Add Signals window reappears, showing the module as the selected destination.

NOTE. *The Add Signals window shows the amount of Kbytes selected (Total Tagged) and the amount available on the module. If the tagged total is greater than the amount available, the signal sets will not load.*

9. Touch **Start Load**. The signal sets are automatically loaded into the module. A popup window tells you when the transfer is complete.

Installing Signals to a Non-default Destination.

1. Insert the test signal disk into the TG 2000 Platform mainframe disk drive.
2. Push the **DISK** button.
3. Touch **Add Signals** when the Disk menu appears.
4. Touch **Select Source**.
5. Move the cursor to the .DNL you want to load and push the **Select** button.
6. Move the cursor to a particular test signal in the test signal field, and push the **Select** button.
7. Touch **Quit/Load**. The previous menu appears.
8. Touch **Quit/Load** again. The Add Signals window reappears.

NOTE. *The Add Signals window shows the amount of Kbytes selected (Total Tagged) and the amount available on the module. If the tagged total is greater than the amount available, the signal sets will not load.*

9. Touch **Select Destination**.
10. Move the cursor to the signals field and place the cursor where you want the test signal to be installed. Be sure to chose a destination that is one level

above the source (i.e. a signal file must be installed into a signal directory, not into another signal file). Press the **Select** button.

11. Touch **Quit/Load**. The Add Signals window reappears.
12. Touch **Start Load** to start the transfer. A popup window tells you when the transfer is complete.

Signal Backup and Module Removal

Before removing a generator module, you should save the signal sets to a disk. The HDVG1 Generator module will lose its signal memory 30 seconds after you remove it from the platform.

Signal Backup

Save the signal sets as follows:

1. Insert a DOS formatted disk into the platform's disk drive.
2. Push the **Disk** button and touch **Save Signals to Disk**.
3. Touch **Select Source**.
4. Use the **NAVIGATION** arrows to move the cursor to the **HDVG1**, and push the **Select** button.
5. Move the cursor to the **HDVG1** module in the signals field and push the **Select** button.
6. Touch **Quit/Save**.
7. Touch **Select Destination** and choose **A:**.

If desired, you may create a new directory for the signals by selecting **New Dir** and entering a DOS compatible name.
8. You must give the file a new filename. Create a new file by touching **New File** and entering a DOS compatible name.
9. Touch **Quit/Save** to return to the **Save Signals to Disk** window..
10. Touch **Start Save**. Saving signals may take several minutes, depending on the number and size of test signals. A popup window tells you when the transfer is complete.

Module Removal

To remove the module, follow these steps:

1. Turn off the platform by pressing the front-panel **On/Standby** switch and switching the rear panel power switch to off.
2. Unplug the power cord.



WARNING. To avoid a shock hazard always unplug the power cord before removing the top cover. Failure to unplug the power cord can result in serious injury or death.

3. Remove all top-cover screws and remove the top cover. See Figure C-2 on page C-3.
4. Remove the appropriate rear panel as shown in Figure C-3 on page C-4. Loosen, but do not remove the bottom screw. You will use it later to secure the rear panel.
5. Refer to Figure C-6 on page C-6 and remove the top screw.



CAUTION. The module will lose its signal memory 30 seconds after you remove it from the TG 2000 Platform mainframe. Before removing the module, be sure you have performed Signal Backup (page C-8). To save instrument settings and presets in addition to test signals, you must perform an Instrument Backup, which is described in the HDVG1 Service manual.

6. Remove the module. To leave the slot empty, proceed to step 8 of this procedure.
7. To install a module in the empty slot, proceed to *Module Installation* on page C-2.
8. To ensure proper cooling and adherence to EMI shielding requirements, install a blank panel to cover any empty slots in the rear panel. A spare blank panel is included in the TG 2000 Platform mainframe accessories kit.
9. Tighten the screws on the blank rear panel.
10. Reinstall the top cover and insert and tighten all top cover screws.

Glossary

APH

Active Picture Height.

Black Burst

Also called “color black,” black burst is a composite video signal consisting of all horizontal and vertical synchronization information and burst. Typically used as the house reference synchronization signal in television facilities.

Burst

A small reference packet of the subcarrier sine wave sent on every line of video. Since the carrier is suppressed, this phase and frequency reference is required for synchronous demodulation of the color difference signals in the receiver.

Chrominance

Chrominance refers to the color information in a television picture. Chrominance can be further broken down into two properties of color: hue and saturation.

Chrominance Signal

The high-frequency portion of the video signal, obtained by quadrature amplitude modulation of a 4.43 MHz (PAL) or 3.58 MHz (NTSC) subcarrier with R-Y and B-Y information.

Component Video

A video signal made up of the individual component parts to reproduce a color picture.

Composite Video

A single video signal containing all of the necessary information to reproduce a color picture. Created by adding quadrature amplitude modulated U and V to the luminance signal.

Frame

A frame (sometimes called a “picture”) contains all the information required for a complete picture. For interlaced scan systems, there are two fields in a frame.

GBR

Green Blue, and Red. The three primary colors used in color television's additive color reproduction system. These are the three color components generated by the camera and used by the monitor to produce a picture.

Luminance

The signal which represents brightness, or the amount of light in the picture. This is the only signal required for black and white pictures, and for color systems it is obtained as a weighted sum ($Y = 0.3R + 0.59G + 0.11B$) of the R, G, and B signals.

NTSC

National Television System Committee. The organization that developed the television standard currently in use in the United States, Canada and Japan.

PAL

Phase Alternate Line. Refers to one of the television systems used in Europe and many other parts of the world. The phase of one of the color difference signals alternates from line to line to help cancel out phase errors.

P_B

A color difference signal used in component video systems. It is derived by subtracting the B (blue) signal from Y.

P_R

A color difference signal used in component video systems. It is derived by subtracting the R (red) signal from Y.

Quick Draw Mode

Enables an overlay to draw faster while you are changing values. Full resolution and edge shaping is invoked once values stop changing.

SCPI

Standard Commands for Programmable Instruments. SCPI is a standard that provides guidelines for remote programming of instruments. These guidelines provide a consistent programming environment for instrument control and data transfer.

Signal Set

A set of industry standard test signals provided by Tektronix on floppy disks.

Soft key

An item on the display that changes state or initiates an action when you touch it on screen. You use soft keys to select test signals or enter a file name.

Termination

In order to accurately send a signal through a transmission line, there must be an impedance at the end which matches the impedance of the source and of the line itself. Amplitude errors and reflections will otherwise result.

Video is a 75 Ω system, so a 75 Ω terminator must be put at the end of the signal path.

Y

Abbreviation for luminance.

Index

A

- Accessories
 - optional, 1–2
 - standard, 1–2
- Active Signal Parameters, 2–7
- Active Signal Parameters window, 2–7
- Add Logo from Disk window, 2–20
- Audio Groups window, 2–16

C

- Certifications and compliances, A–2
- Circle overlay, 2–14
- Circle Overlay window, 2–14
- commands
 - rules for forming, 3–1
 - syntax, 3–1

D

- Delete Logo window, 2–20

E

- Electrical specifications, A–1
- Embedded audio, 1–2, 2–15
- Embedded Audio window, 2–15
- Enable the output signal, 2–15

F

- functional check, 1–3
- Functional command groups, 3–5
- Functional overview, 2–1

H

- Hardware installation, C–2
- HDVG1 features, 1–1
- Hierarchy (SCPI), 3–4

I

- Installation, signal sets, C–6
- Installation, hardware, C–2

L

- Logo File Utilities window, 2–18
- Logo overlay, 2–17
- Logo Overlay window, 2–17

M

- Manuals, related, ix
- Menu structure, 2–1
- Module, removing, C–8
- Module Parameters, 2–13
- Module Parameters window, 2–13
- Module timing, 2–21
- Modules window, 2–4

O

- Online help, 2–2
- Option, 1–3
- Output signal, 2–5
- Output signal enable, 2–15
- Outputs, 2–2

P

- Power on procedure, 2–4
- Product description, 1–1

R

- Rear-panel connectors, 2–2
- Related Manuals, ix
- Removing a module, C–8
- rules, command forming, 3–1

S

- Save Logo to Disk window, 2–18
- Saving signal sets, C–8
- SCPI
 - Conformance information, B–1
 - subsystem hierarchy tree, 3–4
- SCPI commands and queries syntax, 3–4
- Select output signal, 2–5
- Select the module, 2–4

Signal information, 2–12
Signal Information window, 2–12
Signal sets installation, C–6
Signal Sets window, 2–5
Signal sets window, 2–4
Signal Text window, 2–10
Specifications, A–1
Syntax, command, 3–1

T

Text overlay, 2–10
Timing window, 2–21
Trigger output, 2–22

V

Video parameters, 2–8
Video Parameters window, 2–8

W

Window

Active Signal Parameters, 2–7
Add Logo from Disk, 2–20
Audio Groups, 2–16
Circle Overlay, 2–14
Delete Logo, 2–20
Embedded Audio, 2–15
Logo File Utilities, 2–18
Logo Overlay, 2–17
Module Parameters, 2–13
Modules, 2–4
Save Logo to Disk, 2–18
Signal Information, 2–12
Signal Sets, 2–5
Signal sets, 2–4
Signal Text, 2–10
Timing, 2–21
Video Parameters, 2–8